



Jack Wechat



Jack Facebook

JACK

China No.1

Shanghai stock

listed

2021.03

JACK SEWING MACHINE CO.,LTD.

No.1008, Donghai Avenue East, jiaojiang District, Taizhou City, Zhejiang
TEL: 0086-576-88177782 88177767
FAX: 0086-576-88177787

E-mail: sales@chinajack.com
www.chinajack.com

“Make the service smarter
Guide the industry future”



ABOUT JACK

Jack Sewing Machine Co., Ltd was founded in 1995. Jack is a global company which focuses on industrial sewing machine, automatic cutter, power-saving motor, intelligent production management systems R&D, production and marketing. Jack has more than 7000 staff and listed on the main board of the Shanghai Stock Exchange (stock code: 603337).

After more than 20 years of operation and development, Jack has become the largest enterprise in the global sewing equipment industry. It is the only garment intelligent manufacturing complete solution service provider integrating pre-sewing, sewing and software. Products are sold to more than 130 countries around the world, serving the clothing, footwear, luggage, furniture, leather, automotive, aviation and other fields. In recent years, Jack has maintained a stable operation leading in global sales for 9 consecutive years.

Jack has established a large-scale research and development team of thousands of people, which has academician workstation, postdoctoral workstation, key enterprise research institute etc.. Jack introduces and adheres the IPD process and formed a relatively complete product development management system, with more than 1,000 effective patents.

Jack has successively won plenty of national honor, such as the manufacturing single champion model enterprise, China Industrial Award Nomination Award, National Technology Innovation Model Enterprise, National Enterprise Technology Center, National Torch Program key high-tech enterprises, National Intellectual Property Model Enterprise, China's top 50 light industry brands etc.

Jack has acquired German Bullmer, Italian MAICA, Italian VIBEMAC and Anhui TTY company. Through the domestic and foreign mergers and acquisitions to absorb and digest advanced technologies at home and abroad continuously, Jack has formed multi-site collaborative linkage of global R&D platform, such as Germany, Italy, Beijing, Hangzhou, Xi'an, Wuhan, Taizhou, Chizhou.

From "made in China" to "created in China", Jack will stand out in the international sewing equipment

industry:

To make it no difficulty to do garments manufacturing

And let the "intelligent manufacturing in China" led the world trend!

CHINA NO.1

Jack vigorously promotes the integration of the two innovation, and enhance the ability to respond to the market changes quickly. With the corporate mission: provide the best sewing machinery with optimum cost-performance ratio to all, and the corporate spirit: harmony, honesty, struggling, rise, JACK keeping pace with the times, developing and innovating to follow up a new round of global industrial revolution, to build the "WISDOM FACTORY" with wisdom data, intelligent manufacturing and intelligence services, therefore making unremitting efforts to create "the NO.1 Sewing Machine Brand all Over the World".

Jack have got great achievement such as.

No.1 of Sewing Machine Industry in China Light Industry Comprehensive Evaluation;

No.1 of Export Sales for Consecutive Eight Years;

No.1 Sales in Quantity in Sewing Machine Field all Around the Word.

Jack is worthy the title of "China No.1"



MAKE CUSTOMER HAPPY



ZARA

BOSS
HUGO BOSS

UNI
QLO

Semir
森馬

ETERNA

Bally Barclay
SHOE FASHION

Metersbonwe
美特斯·邦威

波司登
BOSIDENG
HIGH QUALITY COSTUME

adidas

NIKE

PUMA

LI-NING

PEAK

HLA
海澜之家

浪莎
Langsha

报喜鸟
SAINT ANGELO

JUDGER
佳吉

南极人
NANJIREN

PEACBIRD
太平鸟集团

LUOLAI
罗莱家纺

罗兰家纺

Amer
爱慕

天堂伞业

FEIZI
菲姿
WOMEN'S WEAR

HU BAO
CLASSIC
虎豹男装

EVER-GLORY

沛浪
PEI LANG

大帝集团
MONNARCH GROUP

YISHION 以纯

FAPA
法派

千千万
kikiw'n

帝牌男装

Yeba
黑豹集团

宏达制衣

GBIQ
斯美泰包袋

QIAOZHIWANG
舒适之王
乔治王

洛兹集团

恒安集团
HENGAN

ASIA LINK GROUP, INC.
联亚集团有限公司

國人西服
GUOREN

QINMAN
琴曼

AOBENNI
奥奔妮

GXG
GILL MIX GREEN

PERTER TEVERE
派登服饰

JODOLL
乔顿服饰

洁丽雅
grace

WONDERFUL JACK



STRONG R&D STRENGTH

- 10 R&D Centre
- 1000 members R&D team
- Nearly 1000 patents, leading the industry

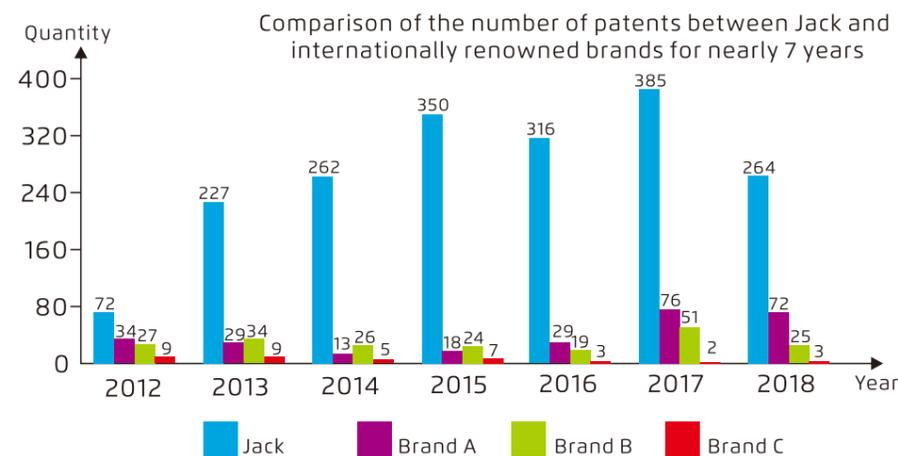

R&D PATENT

Jack encourages innovation and continuously enhances the innovation of enterprises. Since 2012, the number of patents has been increasing. In 2016, 300 patents were applied, of which 210 were invention patents. The quality of patents and technological breakthroughs have been increasing year by year. The best in the industry.

JACK HONOR



Zhejiang Quality Award



Zhejiang Manufacturing Certificate



Asian Design Award



Top 100 China Light Industry



Competitive Enterprises of National Intellectual Property



9000



14000



18000



SALES NETWORK

Jack sales network located in more than 130 countries and has more than 5000 sales and service centre.





Supplier: ensure the quality and efficiency from the beginning.



Agent: ensure the service quality for end-user.



Apparel Industry: meet the commands and boost the industry upgrading.

SMART SERVICE

Build more than 5000 quick service centres in the future.

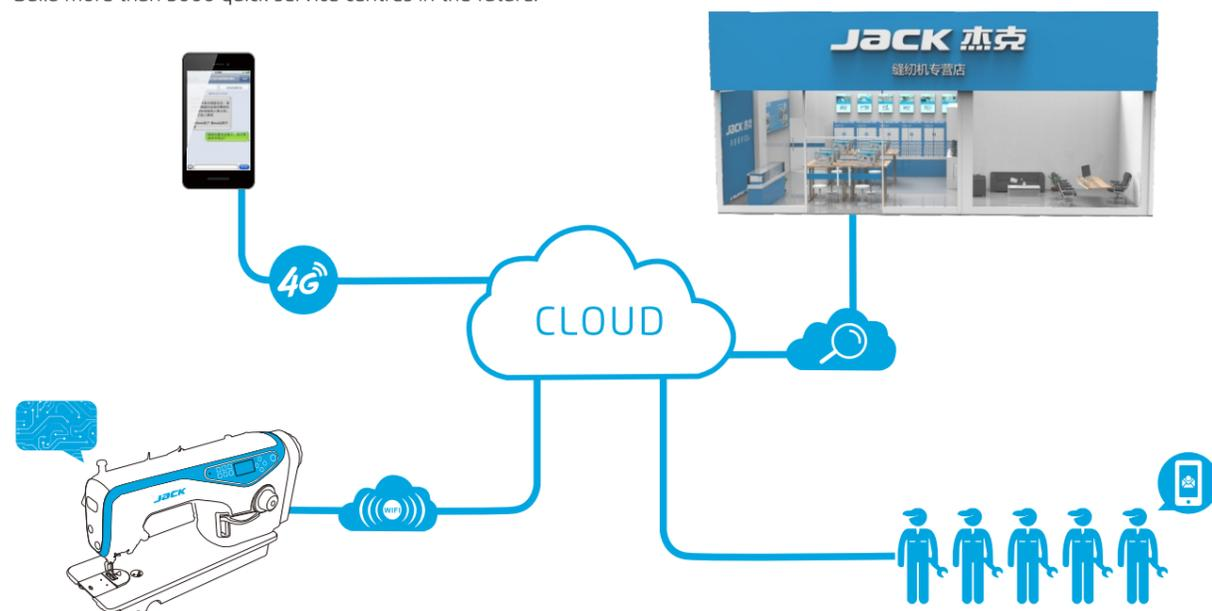

ADVANCED EQUIPMENT: INTELLIGENT PRODUCING LINE

The first intelligent line finishing production by investing 100 million RMB, no need manpower, increase efficiency, improve the product accuracy and ensure the high-quality.



JACK A-SHARE LISTED COMPANY



Successfully listed in Shanghai stock market

Product list

Lockstitch Machine Series

A5E Large Space Computerized Lockstitch Machine	03
A4E Quiet Computerized Lockstitch Machine	04
A6F Computerized Needle Feed Lockstitch Machine	05
A5-W Semi-dry Thread Cleanness Computerized Lockstitch Machine	06
A3E High Speed Stepping Computerized Lockstitch Machine	07
A2S High Speed Computerized Lockstitch Machine	08
A2 Automatic Trimmer Lockstitch Machine	08
F4 Power Saving Lockstitch Machine	09
JK-58450J Computerized Double Needle Lockstitch Machine	10
JK-5559G Semi-dry Computerized Lockstitch Machine With Edge Cutter	11
JK-8558G Power Saving Chain Stitch Machine	12

Overlock Machine Series

C5S Thread Cleanness Pneumatic Automatic Overlock Machine	15
C5(Electric) Light And Heavy Quick Adjustable, Automatic Overlock Machine	16
C4 High Speed Automatic Overlock Machine	17
C3 High Speed Automatic Overlock Machine	18
E4S Adjustable Power Saving Overlock Machine	19
E3 Power Saving Overlock Machine	20
JK-797TDI Small Cylinder-bed Variable Top Feed Power Saving Overlock Machine	21
JK-798TE Variable Top Feed Computerized Overlock Machine	22

Interlock Machine Series

K5E Super high speed computerized cylinder bed interlock with stepping motor system	27
K5-UT Super High Speed Computerized Cylinder-bed Interlock Machine	28
W4-UT High Speed Computerized Flat-bed Interlock Machine	29
JK-8670BDII-UT High Speed Computerized Small Cylinder-bed Interlock Machine	30
JK-8009VCDII/UTL High Speed Computerized Multi-needle Machine	31
JK-8740-460-02/D/AW/S 4 Needles 6 Thread Feed-off-arm Interlock Machine	32

JK-8787-01GX356/UT Super High Speed Computerized Cylinder-bed Interlock Machine	33
---	----

JK-8770-01GX356/UT High Speed Computerized Small Cylinder-bed Interlock Machine	34
---	----

Special Machine Series

MX-100A 360 Degree Needle Bar Rotation Template Sewing Machine	39
MS-100A Super Large Sewing Area Template Machine	40
MG-80A Intelligent Template Machine	41
MS-90A Intelligent Large-area Template Sewing Machine	42
MG-60A Flexible Size Template Sewing Machine	43
Programmable Electronic Pattern Sewing Machine Series	44
JK-T5878-68B/78 Automatic Pocket Welting Machine	45
JK-T5878-58G Automatic Placket Setting Machine	46
JK-T9270D/9280D Direct Drive Feed-off-the Arm Machine	47
JK-T1900G Thread Cleanness High Speed Electronic Bar Tacking & Button Attaching Machine	48
JK-T1903GR Electronic Button Attaching Machine	49
JK-T1790G High Speed Electronic Lockstich Buttonholing Machine	50
JK-T781G New Integrated Electronic Lockstitch Buttonholding Machine	51
JK-T1377E Integrated Computerized Button Attaching Machine	52
JK-T373E Integrated Computerized Button Attaching Machine	52
PZ5 Spreading Machine For Knit And Woven	53
P55 Woven Fabric Spreading Machine	54

Heavy-duty Machine Series

JK-2002G Large Hook Computerized Heavy-duty Lockstitch Machine	57
JK-2060G Compound Feeding Computerized Lockstitch Machine For Heavy-duty	58
JK-2030G Top & Bottom Feeding Computerized Lockstitch Machine For Heavy-duty	58
H6 Top & Bottom feeding computerized lockstitch machine for heavy duty (Stepping type)	59
H5K Side cutter synchronous computerized heavy duty lockstitch sewing machine	60
H5 Top Bottom Feeding Computerized Lockstitch Machine For Heavy-duty	61
S7 Intelligent-Control Computerized Post Bed Roller Feed Sewing Machine	62
S5 High Speed Computerized Post Bed Roller Feed Sewing Machine	63
JK-6671C/6672C Intelligent-Control Computerized Post Bed Roller Feed Sewing Machine	64

Make the service smarter

Smart service is not only offering on-time after-sales service, but also helping operators to solve the problem with the intelligent human-computer interaction.



Lockstitch Machine Series

A5E

Large Space Computerized Lockstitch Machine



Large Space, High Precision Stitch, Short Thread Remaining



The Largest Operation Space 305mmx130mm, Give Sewing More Imagination



High Precision Stitch



No Oil No Trouble, Clean And Durable

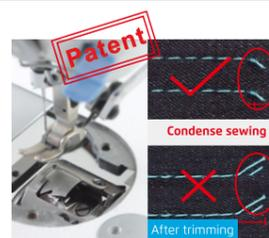

Beautiful Stitches, Short Thread Remaining

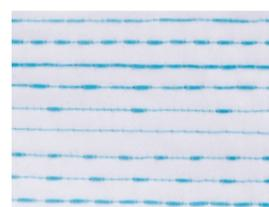

Variable Stitches, Fashionable And Beautiful

Model	Needle	Thread No.	Stitch Length (mm)	Presser Foot Lifting Height (mm)	Max. Speed (S.p.m)	Light/Medium Heavy Duty	Heavy Duty	Volume (mm)	Weight (kg)
A5E	DBx111-18#	2	5	5-13	5000	√		690x295x550	42.5/48.5
A5E-H-M	DBx111-18#	2	5	5-13	5000	√		690x295x550	42.5/48.5
A5E-H	DPx5 18-21#	2	5	5-13	3500		√	690x295x550	42.5/48.5
A5E-7	DBx111-18#	2	7	5-13	3500	√		690x295x550	42.5/48.5

Note: Japanese hook, auto trimming, auto reverse sewing, auto presser foot lifter, electronic thread nipper, 5mm stitch length, 7mm stitch length is optional(-7).

A4E

Quiet Computerized Lockstitch Machine



Low Noise, High Precision Stitch

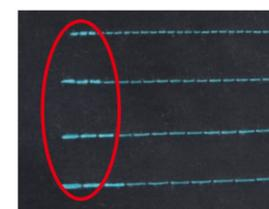

High Stitch Overlapping Ratio

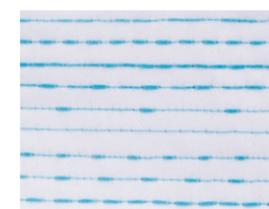

Variable Stitches, Fashionable and Beautiful

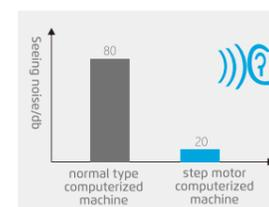

Noiseless Reverse Sewing

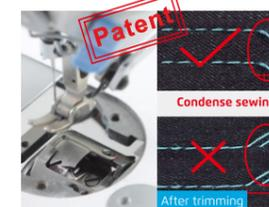

Short Thread Remaining



High Precision Stitch

Model	Needle	Thread Number	Max Stitch Length (mm)	Presser Foot Lifter Height (mm)	Max Speed (s.p.m)	Thin / medium thick	Thick material	Volume (mm)	Weight (kg)
A4E	DBx111-18#	2	5	5-13	5000	√	/	695x295x550	41/47
A4E-H-M	DBx111-18#	2	5	5-13	5000	√	/	695x295x550	41/47
A4E-H	DPx5 18-21#	2	5	5-13	3500	√	√	695x295x550	41/47
A4E-CP	DBx111-18#	2	5	5-13	5000	√	/	695x295x550	41/47

Note: Japanese hook, auto trimmer, auto reverse sewing, auto presser foot lifter, electronic tension post, 5mm stitch length, 7mm stitch length is optional, p means multiples of 1.6 hook.

A6F

Computerized Needle Feed Lockstitch Machine



Full-automatic, Needle Feed, Short Thread Remaining, Semi-dry

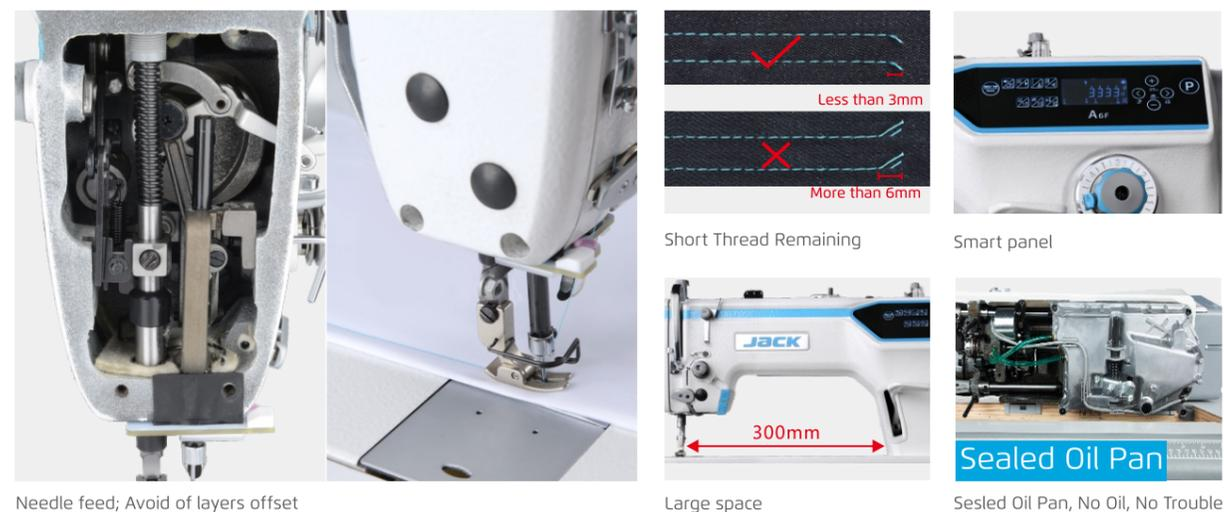

Needle feed; Avoid of layers offset

Large space

Sealed Oil Pan, No Oil, No Trouble

Model	Needle	Thread No.	Stitch Length (mm)	Presser Foot Lifting Height (mm)	Max. Speed (s.p.m)	A/M	H	Volume (mm)	Weight (kg)
A6F	DBx1 11-18#	2	4.5	5-13	4000	√		695×315×670	45/52
A6F-H	DPx5 18-21#	2	4.5	5-13	3500		√	695×315×670	45/52

Note: auto thread trimming, auto reverse, auto presser foot lifter, electronic thread tension are equipped as standard.

A5-W

Semi-dry Thread Cleaness Computerized Lockstitch Machine



Full-automatic, Short Thread Remaining, Semi-dry



Sealed oil pan

Needle feed; Avoid of layers offset

Model	Needle	Thread No.	Stitch Length (mm)	Presser Foot Lifting Height (mm)	Max. Speed (s.p.m)	A	M	Volume (mm)	Weight (kg)
A5-W	DBx1 11-18#	2	5	5-13	5000	√		645×248×550	40/46
A5-W-7	DBx1 11-18#	2	7	5-13	3500	√		645×248×550	40/46
A5-WH-M	DBx1 11-18#	2	5	5-13	5000	√		645×248×550	40/46
A5-WH	DPx5 18-21#	2	5	5-13	3500		√	645×248×550	40/46
A5-WD	DBx1 11-18#	2	5	5-13	5000	√		645×248×550	40/46
A5-WN	DBx1 11-18#	2	5	5-13	5000	√		645×248×550	40/46
A5-WND	DBx1 11-18#	2	5	5-13	5000	√		645×248×550	40/46

Note: auto thread trimming, auto reverse, auto presser foot lifter, and electronic thread tension are equipped as standard.
D: bobbin thread detection is optional.
N: less bird-nest device, pneumatic and electronic suction device are optional.

A3E

High Speed Stepping Computerized Lockstitch Machine



Accurate stitch length, noiseless reverse sewing, short remaining thread, suitable for light and heavy duty materials

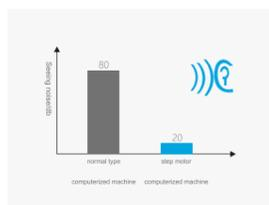

Noiseless reverse sewing, quiet and comfortable



For light and heavy duty materials, easy and convenient

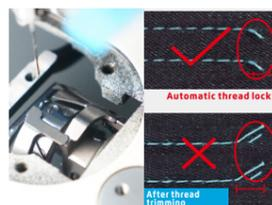

Short thread remaining, no need to trim again

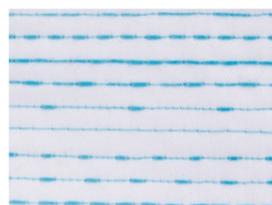

variable stitches, fashionable and beautiful



Accurate stitch length, lock easily.

Model	Needle	Thread No.	Stitch Length (mm)	Presser Foot Lifting Height (mm)	Max. Speed (s.p.m)	A/M	H	Volume (mm)	Weight (kg)
A3E-CQ	DBx1 11-18#	2	5	5-13	5000	✓		690x295x550	39.5/45.5
A3E-4CQ	DBx1 11-18#	2	5	5-13	5000	✓		690x295x550	39.5/45.5
A3E-4CHQ-M	DBx1 11-18#	2	5	5-13	5000	✓		690x295x550	39.5/45.5
A3E-4CHQ	DPx5 18-21#	2	5	5-13	3500		✓	690x295x550	39.5/45.5
A3E-4CHQ-7	DPx5 18-21#	2	7	5-13	3500		✓	690x295x550	39.5/45.5
A3E-4CHLQ-7	DPx5 18-21#	2	7	5-13	3500		✓	690x295x550	39.5/45.5



A2S

High Speed Computerized Lockstitch Machine
Auto-reverse



A2

Automatic Trimmer Lockstitch Machine
Auto-trimmer

A2S



New design



One main shaft



Factory reset



Cooling fan

Model	Needle	Thread No.	Stitch Length (mm)	Presser Foot Lifting Height (mm)	Max. Speed (s.p.m)	A/M	H	Volume (mm)	Weight (kg)
A2S-CZ	DBx1 11-18#	2	5	5-13	5000	✓		671x248x550	34/41
A2S-CHZ-M	DBx1 11-18#	2	5	5-13	5000	✓		671x248x550	34/41
A2S-CHZ	DPx5 18-21#	2	5	5-13	3500		✓	671x248x550	34/41
A2S-4CZ	DBx1 11-18#	2	5	5-13	5000	✓		671x248x550	34/41
A2S-4CHZ-M	DBx1 11-18#	2	5	5-13	5000	✓		671x248x550	34/41
A2S-4CHZ	DPx5 18-21#	2	5	5-13	3500		✓	671x248x550	34/41

Note: auto thread trimming, auto reverse, electronic thread tension are equipped as standard.
-4: auto presser foot lifter.

A2



Auto thread trimming



LED light



Cooling fan

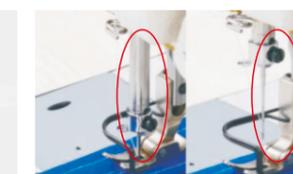

Needle position

Model	Needle	Thread No.	Stitch Length (mm)	Presser Foot Lifting Height (mm)	Max. Speed (s.p.m)	A/M	H	Volume (mm)	Weight (kg)
A2-CZ	Dbx1 11-18#	2	5	5-13	5000	✓		671x248x550	34/41
A2-CHZ-M	DBx1 11-18#	2	5	5-13	5000	✓		671x248x550	34/41
A2-CHZ	DPx5 18-21#	2	7	5-13	3500		✓	671x248x550	34/41
A2-CHZ-7	Dpx5 18-21#	2	7	5-13	3500		✓	671x248x550	34/41

Note: auto thread trimming is equipped as standard.

F4

Power Saving Lockstitch Machine



Power Saving Lockstitch Machine

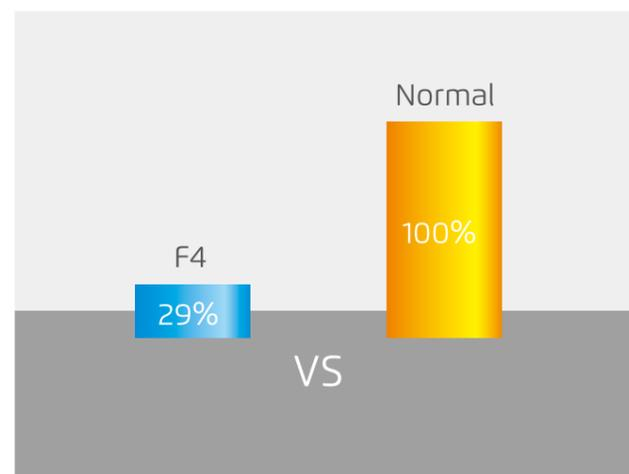

Power saving 71%



Convenient thread cutter

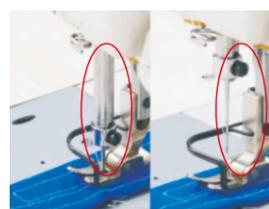

Needle position



LED light

Model	Needle	Thread No.	Stitch Length (mm)	Presser Foot Lifting Height (mm)	Max. Speed (s.p.m)	A/M	H	Volume (mm)	Weight (kg)
F4	DBx1 11-18#	2	5	5-13	5000	√		645x248x550	32/38.7
F4-H	DPx5 18-21#	2	5	5-13	3500		√	645x248x550	32/38.7
F4-7	DBx1 11-18#	2	7	5-13	3500	√		645x248x550	32/38.7
F4-H-7	DPx5 18-21#	2	7	5-13	3500		√	645x248x550	32/38.7
F4-HL-7	DPx5 18-21#	2	7	5-13	3000		√	645x248x550	32/38.7

Note: L: Large hook.

JK-58450J

Computerized Double Needle Lockstitch Machine



Straight cutter, Auto cornering, Large space

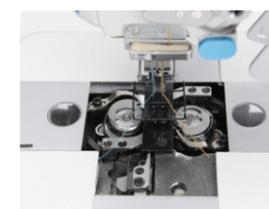

Straight knife



Split needle bar

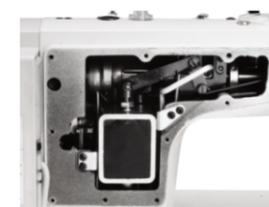

Built-in presser foot lifter



For different thickness of thread

Model	Needle	Stitch Length (mm)	Needle Gauge (mm)	Presser Foot Lifting Height (mm)	Max. Speed (s.p.m)	Application	Function	Auto Corner Sewing	Large Hook	Volume (mm)	Weight (kg)
JK-58420B-003/JK-58420B-005	DPx5 11-16#/14-22#	4/5	6.4	7-13	3000	A/H	Straight Stitch			725x320x675	47.5/58
JK-58450B-003/JK-58450B-005	DPx5 11-16#/14-22#	5	6.4	7-13	3000	A/H	Corner Stitch			725x320x675	47.5/58
JK-58720B-003/JK-58720B-005	DPx5 11-16#/14-22#	7	6.4	7-13	3000	A/H	Straight Stitch	√		725x320x675	47.5/58
JK-58750B-003/JK-58750B-005	DPx5 11-16#/14-22#	7	6.4	7-13	3000	A/H	Corner Stitch		√	725x320x675	47.5/58
JK-58420J-403E/JK-58420J-405E	DPx5 11-16#/14-22#	4/5	6.4	7-13	3000	A/H	Straight Stitch			725x320x675	53/63
JK-58450J-403E/JK-58450J-405E	DPx5 11-16#/14-22#	5	6.4	7-13	3000	A/H	Corner Stitch			725x320x675	53/63
JK-58450J-413E/JK-58450J-415E	DPx5 11-16#/14-22#	5	6.4	7-13	3000	A/H	Corner Stitch	√		725x320x675	53/63
JK-58720J-403E/JK-58720J-405E	DPx5 11-16#/14-22#	7	6.4	7-13	3000	A/H	Straight Stitch		√	725x320x675	53/63
JK-58750J-403E/JK-58750J-405E	DPx5 11-16#/14-22#	7	6.4	7-13	3000	A/H	Corner Stitch		√	725x320x675	53/63
JK-58750J-413E/JK-58750J-415E	DPx5 11-16#/14-22#	7	6.4	7-13	3000	A/H	Corner Stitch	√	√	725x320x675	53/63

Note: 1.B is direct drive, Chinese hook is standard; the imported hook can be optional. 2.J is computerized, auto trimmer, auto reverse, auto presser foot lifter, auto wiper are as standard; the electronic thread tension is optional, the model is 403E/405E.

JK-5559G

Semi-dry Computerized Lockstitch Machine With Edge Cutter



Semi-dry, Coaxial driving

JK-8558G

Power Saving Chain Stitch Machine



Power saving

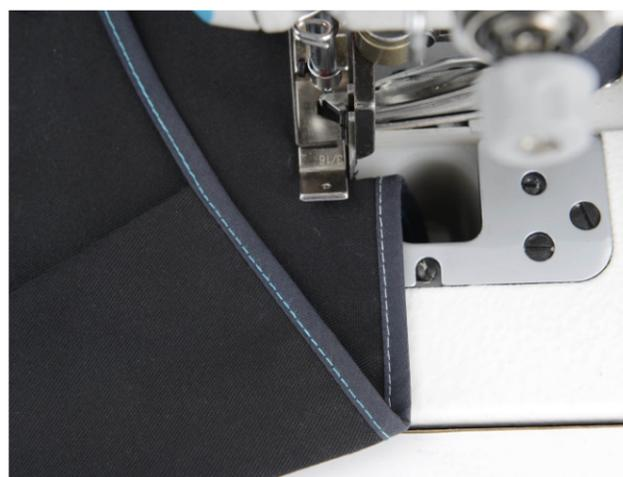

Edge cutter and tape binder (JK-5558G-T)



Semi-dry



Large space



One main shaft



Auto presser foot lifter



Rear puller



Slant type needle Trigonal type needle

Two needle gauges (JK-8560G)

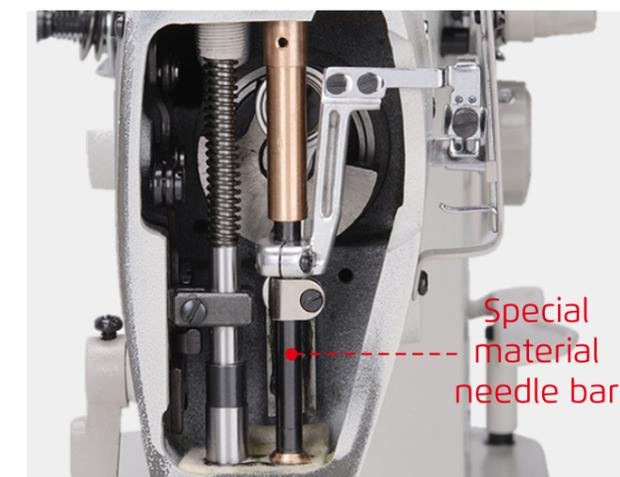

Semi-dry

Special material needle bar

Model	Needle	Thread No.	Stitch Length (mm)	Distance between Needle&Knife (mm)	Presser Foot Lifting Height (mm)	Max. Speed (s.p.m)	A/M	Volume (mm)	Weight (kg)
JK-5559G-W	DBx1 11-18#	2	5	1/8"	5-13	5000	√	645x248x550	32/38.7
JK-5558G-W	DBx1 11-18#	2	5	1/8"	5-13	4000	√	645x248x550	32/38.7
JK-5558G	DBx1 11-18#	2	5	1/8"	5-13	4000	√	645x248x550	32/38.7
JK-5558G-WT	DBx1 11-18#	2	5	1.3/16"	5-13	4000	√	645x248x550	32/38.7
JK-5558G-T	DBx1 11-18#	2	5	1.3/16"	5-13	4000	√	645x248x550	32/38.7

Note: 1. JK-5559G-W is computerized type, semi-dry, auto thread trimming, auto reverse, auto presser foot lifter, electronic thread tension are equipped as standard.
2. JK-5558G is direct drive type.
3. W: dry head; T: with fabric edge cutter and tape binder.

Model	Needle Array	Needle Gauge	Needle	Needle No.	Thread No.	Needle Distance (mm)	Presser Foot Height (mm)	A	M	H	Max. Speed (s.p.m)	Volume (mm)	Weight (kg)
JK-8558G-WZ	Parallel Double Needle	1/4,3/16, 1/8,3/8	TVx7 14#	2	4	1.4-4	4.5 (knee Control 8-10)	√	√		4000	675x275x595	39/47
JK-8558G-WTZ	Parallel Double Needle	1/4,3/16, 1/8,3/8	TVx7 14#	2	4	1.4-4	4.5 (knee Control 8-10)	√	√		4000	675x275x595	39/47
JK-8558G-1WZ	Single Needle	-	TVx7 14#	1	2	1.4-4	4.5 (knee Control 8-10)	√	√		4000	675x275x595	39/47
JK-8558G-2WZ	Vertical Double Needle	3/16	TVx7 14#	2	4	1.4-4	4.5 (knee Control 8-10)	√	√		4000	675x275x595	39/47
JK-8560G-WZ	Slant Three Needle	1/8	TVx7 14#	3	6	1.4-4	4.5 (knee Control 8-10)	√	√		4000	675x275x595	39/47
JK-8560G-WZ-PL	Slant Three Needle	1/8	TVx7 18#	3	6	1.4-4	4.5 (knee Control 8-10)		√		4000	675x275x595	39/47
JK-8560G-PHWZ	Trigonal Three Needle	1/8	TVx7 21#	3	6	1.4-4	4.5 (knee Control 8-10)	√	√		4000	675x275x595	39/47

Note: T: auto presser foot lifter, 8558G/8560G: auto presser foot lifter is optional.
PL: rear puller.
PL(X): Rubber puller.

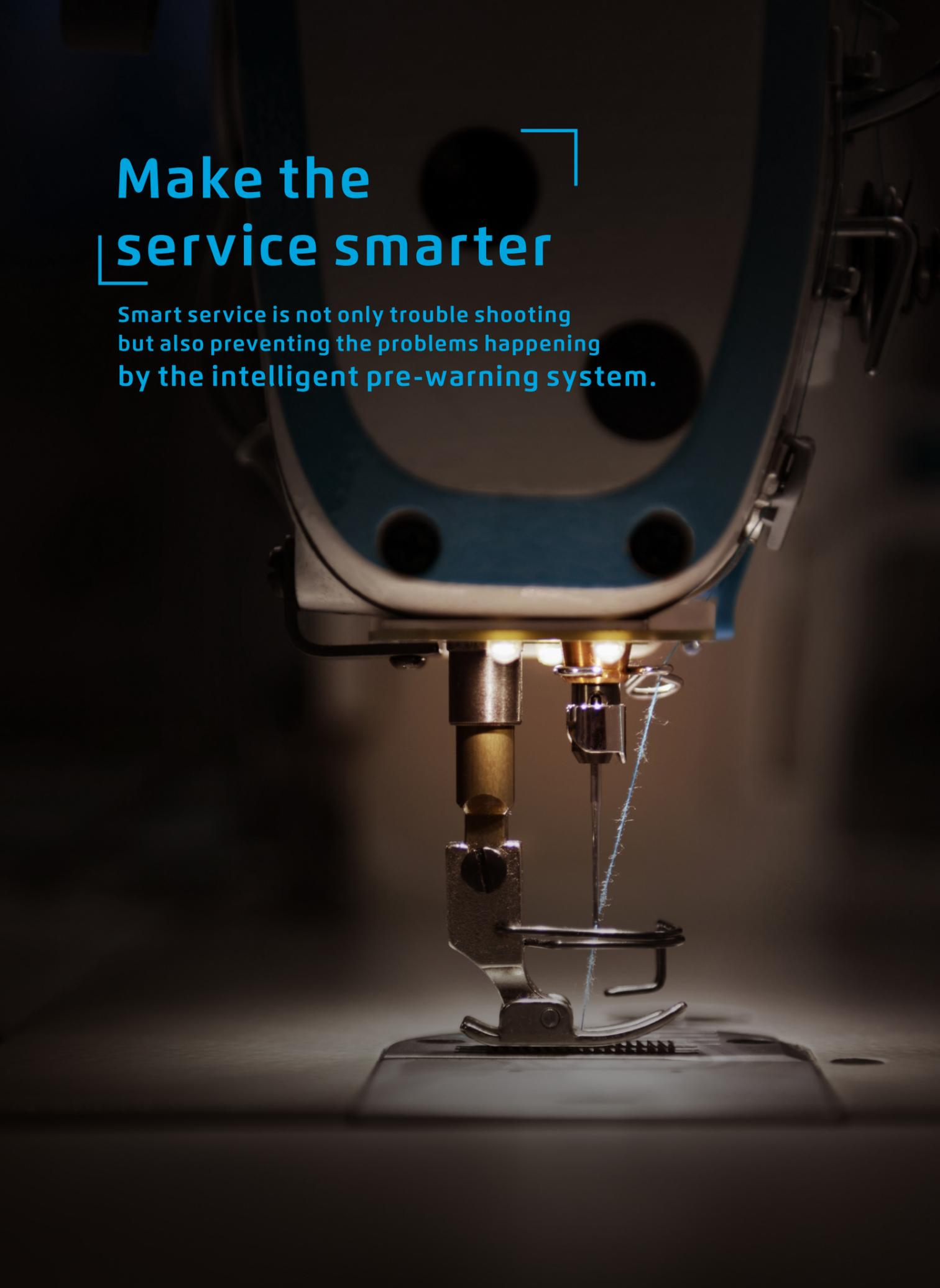

Make the service smarter

Smart service is not only trouble shooting
but also preventing the problems happening
by the intelligent pre-warning system.

Overlock Machine Series

C5S(Pneumatic)

Thread Cleanness Pneumatic Automatic Overlock Machine



Short Thread Remaining, Clean Sewing, Light and Heavy Adjustable, Stable and Durable



Thread Cleanness

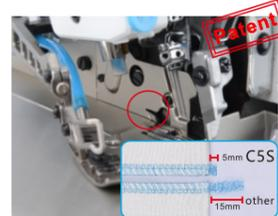

Short Thread Remaining



Stable and Durable



Light and Heavy Adjustable, Wide Application

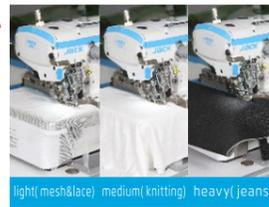

Model	Needle	Needle No.	Thread No.	Needle Distance (mm)	Stitch Width (mm)	Stitch Length (mm)	Differential Ratio	Presser Foot Lifting Height (mm)	Max. Speed (s.p.m)	Volume (mm)	Weight (kg)
C5S-02x250/AT(Pocket Binding)	DCx27 14#	2	4	5	-	4	0.7-2	3.5	7000	525x360x630	33/44
C5S-3-02/233/KS(Plain Seaming)	DCx27 11#	1	3	-	4	4	0.7-2	5	7000	525x360x630	33/44
C5S-3-32R2/223/KS(Condense Seaming)	DCx27 9#	1	3	-	1.5	4	0.7-2	5	7000	525x360x630	33/44
C5S-WF-3-02/213/AT(Nonwovens)	DCx27 14#	1	3	-	4	8.5	-	5.5	7000	525x360x630	33/44
C5S-4-M03/333/KS(Plain Seaming)	DCx27 11#	2	4	2	4	4.6	0.7-2	5.5	7000	525x360x630	33/44
C5S-4-M03/333/H/M/KS(Heavy Duty)	DCx27 11#	2	4	2	4	4.6	0.7-2	6	7000	525x360x630	33/44
C5S-4-83/323/BK(Back Latching)	DCx27 11#	2	4	2	4	4.6	0.7-2	3.5	7000	525x360x630	33/44
C5S-MJ-4-53/233/AT(Towel Ending)	DCx27 11#	2	4	2	4	4	0.7-2	5	7000	525x360x630	33/44
C5S-5-53/233/AT(Strip Attaching)	DCx27 14#	2	5	3	5	4	0.7-2	5	7000	525x360x630	33/44
C5S-5-03/233/KH(5X5 Stitch)	DCx27 14#	2	5	5	5	4	0.7-2	5	7000	525x360x630	33/44
C5S-5-03/333/KH(3x4 Stitch)	DCx27 14#	2	5	3	4	4	0.7-2	5	7000	525x360x630	33/44
C5S-5-A04/435/AT(Extra Heavy)	DCx27 19#	2	5	5	6	5	0.8-1.5	7	7000	525x360x630	33/44
C5S-5-M04/435/AT(Denim)	DCx27 19#	2	5	5	6	5	0.8-1.5	7	7000	525x360x630	33/44
C5S-6-03/333/AT(Plain Seaming)	DCx27 11#	3	6	3x2	4	4	0.7-2	5	7000	525x360x630	33/44
C5S-6-M04/435/AT(Especially For Denim)	DCx27 19#	3	6	5x2.5	3.5	5	0.8-1.5	7	7000	525x360x630	33/44

Note: KS: Vertical suction device, KH: Horizontal suction device, AT: Pneumatic cutter trimming, H/M: Wide range for heavy duty; Optional CSW(Semi-dry).

C5(Electric)

Light And Heavy Quick Adjustable, Automatic Overlock Machine



Suitable For Light To Heavy Duty, Short Thread Remaining, Faster



Thickness detection, strong climbing ability

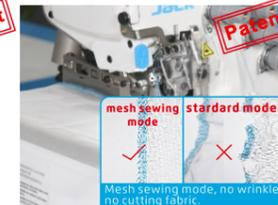

Mesh sewing mode

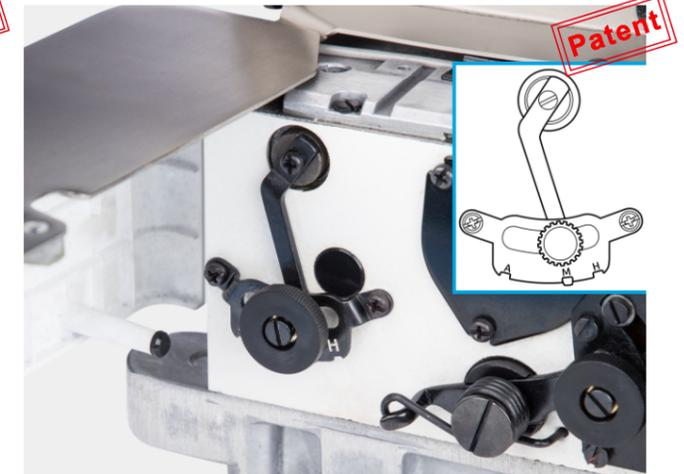

Light and Heavy Adjustable, Suitable for light to heavy duty

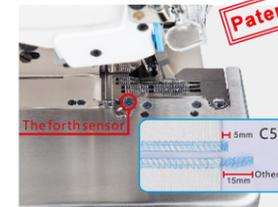

Short thread remaining, no need to trim again

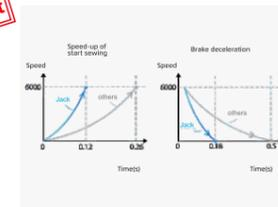

Ultra-fast start and stop, strong power

Model	Needle	Needle No.	Thread No.	Needle Distance (mm)	Stitch Width (mm)	Stitch Length (mm)	Differential Ratio	Presser Foot Lifting Height (mm)	Max. Speed (s.p.m)	Volume (mm)	Weight (kg)
C5-02x250(Pocket Binding)	14#	2	4	5	-	4	0.7-2	3.5	7000	525*360*510	32/41
C5-3-02/233(Plain Seaming)	11#	1	3	-	4	4	0.7-2	5	7000	525*360*510	32/41
C5-3-32R2/223(Condense Seaming)	9#	1	3	-	1.5	4	0.7-2	5	7000	525*360*510	32/41
C5-WF-3-02/213(Nonwovens)	14#	1	3	-	4	8.5	-	5.5	7000	525*360*510	32/41
C5-4-M03/333(Plain Seaming)	11#	2	4	2	4	4.6	0.7-2	5.5	7000	525*360*510	32/41
C5-4-M03/333(Heavy Duty)	11#	2	4	2	4	4.6	0.7-2	6	7000	525*360*510	32/41
C5-MJ-4-53/233(Towel Ending)	11#	2	4	2	4	4	0.7-2	5	7000	525*360*510	32/41
C5-5-53/233(Strip Attaching)	14#	2	5	3	4	4	0.7-2	5	7000	525*360*510	32/41
C5-5-03/233(5X5 Stitch)	14#	2	5	5	5	4	0.7-2	5	7000	525*360*510	32/41
C5-5-03/333(3x4 Stitch)	14#	2	5	3	4	4	0.7-2	5	7000	525*360*510	32/41
C5-5-A04/435(Extra Heavy)	19#	2	5	5	6	5	0.8-1.5	7	7000	525*360*510	32/41
C5-5-M04/435(Denim)	19#	2	5	5	6	5	0.8-1.5	7	7000	525*360*510	32/41
C5-6-03/333(Plain Seaming)	11#	3	6	3x2	4	4	0.7-2	5	7000	525*360*510	32/41
C5-6-M04/435(Denim)	19#	3	6	5x2.5	3.5	5	0.8-1.5	7	7000	525*360*510	32/41

Note: H/M: Light and Heavy materials are good adaptability. SD is optional(start and end suction device), volume: 525x360x640(mm), weight:32/43(kg).

C4

High Speed Automatic Overlock Machine



Full-automatic, Electronic device, Oil-proof, Voice guide



High efficiency

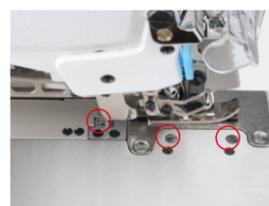

Intelligent recognition of fabric thickness



Voice guide, One key to reset



C4-4/AD
Available to narrow and wide edge

Model	Functions	Needle	Needle No.	Thread No.	Needle Distance (mm)	Stitch Width (mm)	Stitch Length (mm)	Differential Ratio	Presser Foot Lifting Height (mm)	Max. Speed (s.p.m)	Volume (mm)	Weight (kg)
C4-02x250	Pocket Binding Seaming	DCx27 14#	2	4	5	5	3.8	0.7-2	3.5	7000	525x360x510	33/41
C4-3-02/233	Plain Seaming	DCx27 11#	1	3	-	4	3.8	0.7-2	5	7000	525x360x510	33/41
C4-3-12/233	Bottom Hemming	DCx27 11#	1	3	-	4	3.8	0.7-2	5	7000	525x360x510	33/41
C4-3-32R2/223	Narrow Stitch Seaming	DCx27 9#	1	3	-	1.5	3.8	0.7-2	5	7000	525x360x510	33/41
C4-WF-3-02/213	Non-woven Fabric	DCx27 14#	1	3	-	4	8.5	-	5	7000	525x360x510	33/41
C4-4-M03/333	Plain Seaming	DCx27 11#	2	4	2	4	4.6	0.7-2	5.5	7000	525x360x510	33/41
C4-4-M03/333/H/M	Heavy Duty	DCx27 11#	2	4	2	4	4.6	0.7-2	6	7000	525x360x510	33/41
C4-4-M03/333/AD	Adjustable Side Stitch Width	DCx27 11#	2	4	2	4-8	4.6	0.7-2	5.5	7000	525x360x510	33/41
C4-MJ-4-53/233	Towel Ending	DCx27 11#	2	4	2	4	3.8	0.7-2	5	7000	525x360x510	33/41
C4-5-53/233	Strip Attach Seaming	DCx27 14#	2	5	3	4	3.8	0.7-2	5	7000	525x360x510	33/41
C4-5-03/233	5x5 Stitch	DCx27 14#	2	5	5	5	3.8	0.7-2	5	7000	525x360x510	33/41
C4-5-03/333	3x4 Stitch	DCx27 14#	2	5	3	4	3.8	0.7-2	5	7000	525x360x510	33/41
C4-5-A04/435	Extra Heavy Duty	DCx27 19#	2	5	5	6	5	0.8-1.5	7	7000	525x360x510	33/41
C4-5-M04/435	Denim	DCx27 19#	2	5	5	6	5	0.8-1.5	7	7000	525x360x510	33/41
C4-6-03/333	Plain Seaming	DCx27 11#	3	6	3x2	4	3.8	0.7-2	5	7000	525x360x510	33/41

Note: H/M: suitable for heavy and medium material. SD device is available (start and end suction device); volume: 525x360x640 (mm), weight 33/44 (kg).

C3

High Speed Automatic Overlock Machine



Auto-trimmer, Auto presser foot lifter, Oil-proof



Oil-proof needle bar



One key to reset

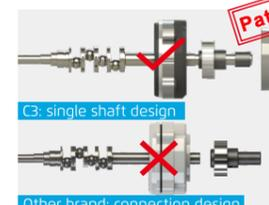

One Main Shaft and fast

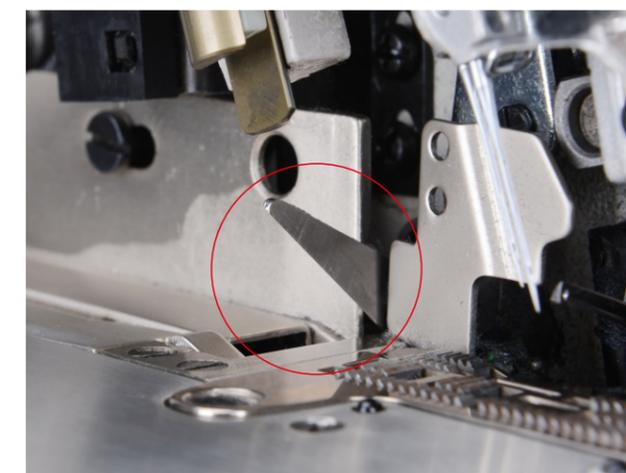

Auto tread trimming

Model	Functions	Needle	Needle No.	Thread No.	Needle Distance (mm)	Stitch Width (mm)	Stitch Length (mm)	Differential Ratio	Presser Foot Lifting Height (mm)	Max. Speed (s.p.m)	Volume (mm)	Weight (kg)
C3-3-02/233	Plain Seaming	DCx27 11#	1	3	-	4	4	0.7-2	5	5800	525x360x510	30/41
C3-4-M03/333	Plain Seaming	DCx27 11#	2	4	2	4	4.6	0.7-2	5.5	5800	525x360x510	30/41
C3-4-M03/333/H/M	Heavy Duty	DCx27 11#	2	4	2	4	4.6	0.7-2	6	5800	525x360x510	30/41
C3-5-03/233	5x5 Stitch	DCx27 14#	2	5	5	5	4	0.7-2	5	5800	525x360x510	30/41
C3-5-03/333	3x4 Stitch	DCx27 14#	2	5	3	4	4	0.7-2	5	5800	525x360x510	30/41
C3-5-A04/435	Extra Heavy Duty	DCx27 19#	2	5	5	6	5	0.8-1.5	7	5800	525x360x510	30/41

Note: H/M: suitable for heavy and medium material.

E4S

Adjustable Power Saving Overlock Machine



Light and heavy adjustable freely, quick response for start and brake

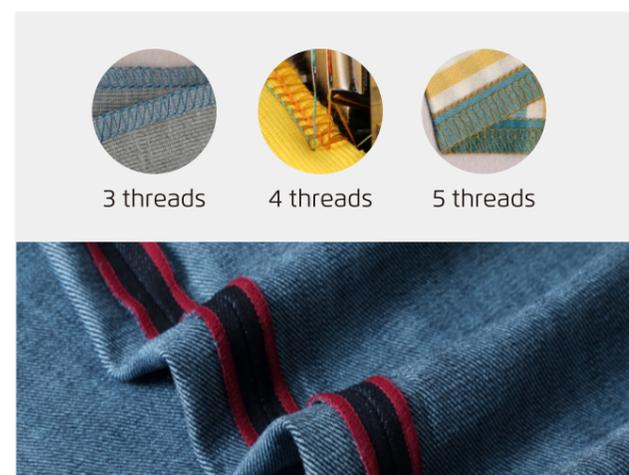

3 threads 4 threads 5 threads

Suitable for light and heavy material

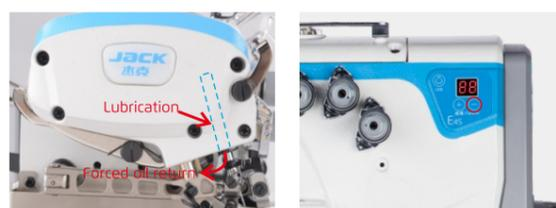

Oil-proof needle bar

Easy to operate

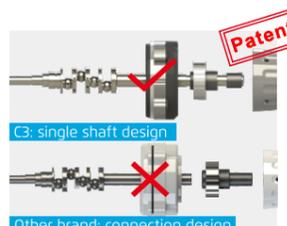

One Main Shaft, Stable and fast

Model	Needle	Needle No.	Thread No.	Needle Distance (mm)	Stitch Width (mm)	Stitch Length (mm)	Differential Ratio	Presser Foot Lifting Height (mm)	Max. Speed (s.p.m)	Volume (mm)	Weight (kg)
E4S-2(Fabric Joint Seaming)	DCx27 11#	1	2	-	6	4	0.7-2	3.5	5500	525x360x510	28/36
E4S-02x250(Pocket Binding Seaming)	DCx27 14#	2	4	5	-	4	0.7-2	3.5	5500	525x360x510	28/36
E4S-3-02/233(Plain Seaming)	DCx27 11#	1	3	-	4	4	0.7-2	5	5500	525x360x510	28/36
E4S-3-82/233(Back Latching)	DCx27 11#	1	3	-	4	4	0.7-2	5	5500	525x360x510	28/36
E4S-3-32R2/233(Narrow Sewing)	DCx27 9#	1	3	-	1.5	4	0.7-2	5	5500	525x360x510	28/36
E4SWF-3-02/213(Non-woven Material)	DCx27 14#	1	3	-	4	8.5	-	5.5	5500	525x360x510	28/36
E4S-4-M03/333(Plain Seaming)	DCx27 11#	2	4	2	4	4.6	0.7-2	5.5	5500	525x360x510	28/36
E4S-4-83/323(Back Latching)	DCx27 11#	2	4	2	4	4.6	0.7-2	5.5	5500	525x360x510	28/36
E4S-4-M03/333/H/M(Heavy Duty)	DCx27 11#	2	4	2	4	4.6	0.7-2	6	5500	525x360x510	28/36
E4SMJ-4-53/233(Towel Ending)	DCx27 11#	2	4	2	4	4	0.7-2	5	5500	525x360x510	28/36
E4S-5-53/233(Tape Attaching Seaming)	DCx27 14#	2	5	3	5	4	0.7-2	5	5500	525x360x510	28/36
E4S-5-02A/233(Light material)	DCx27 11#	2	5	3	4	4	0.7-2	5	5500	525x360x510	28/36
E4S-5-03/233(5x5 Stitch)	DCx27 14#	2	5	5	5	4	0.7-2	5	5500	525x360x510	28/36
E4S-5-03/333(3x4 Stitch)	DCx27 14#	2	5	3	4	4	0.7-2	5	5500	525x360x510	28/36
E4S-5-M04/435(Especially For Denim)	DCx27 19#	2	5	5	6	5	0.8-1.5	7	5500	525x360x510	28/36
E4S-5-A04/435(Extra Heavy Duty)	DCx27 19#	2	5	5	6	5	0.8-1.5	7	5500	525x360x510	28/36
E4S-6-03/333(Plain Seaming)	DCx27 11#	3	6	3x2	4	4	0.7-2	5	5500	525x360x510	28/36
E4S-6-M04/435(Especially For Denim)	DCx27 19#	3	6	5x2.5	3.5	5	0.8-1.5	7	5500	525x360x510	28/36

Note:H/M suitable for light and heavy; optional device KS (vertical suction device) and KH(horizontal suction device); machine volume:525*360*630(mm), weight 28/39(kg).

E3

Power Saving Overlock Machine



Power saving, easy operation



Easy operation, quick response



Fully enclosed needle bar oil return device, clean sewing



Integrated handwheel design

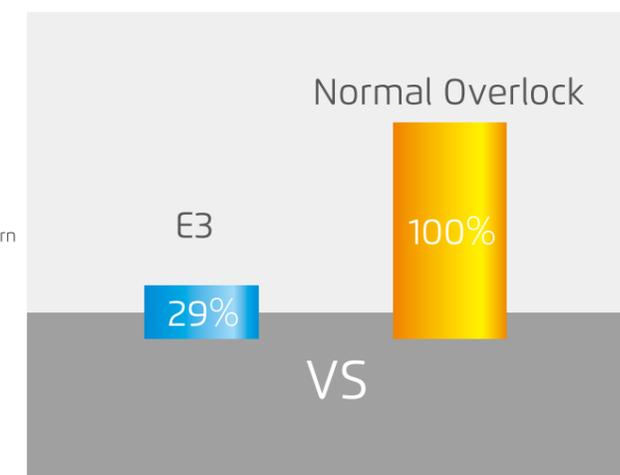

Power saving 71%

Model	Functions	Needle	Needle No.	Thread No.	Needle Distance (mm)	Stitch Width (mm)	Stitch Length (mm)	Differential Ratio	Presser Foot Lifting Height (mm)	Max. Speed (s.p.m)	Volume (mm)	Weight (kg)
E3-3-M1-15	Light material	9#	1	3	/	1.5	4.6	0.7-2	5.5	5500	495x355x545	27.6/36.7
E3-3-M2-04	Plain seaming	11#	1	3	/	4	4.6	0.7-2	5.5	5500	495x355x545	27.6/36.7
E3-3-M5-04/BK	Back latching	11#	1	3	/	4	4.6	0.7-2	5.5	5500	495x355x545	27.6/36.7
E3-4-M5-23/BK	Back latching	11#	2	4	2	3	4.6	0.7-2	5.5	5500	495x355x545	27.6/36.7
E3-4-M2-24	Plain seaming	11#	2	4	2	4	4.6	0.7-2	5.5	5500	495x355x545	27.6/36.7
E3-5-M2-35	Plain seaming	14#	2	5	3	5	4.6	0.7-2	5	5500	495x355x545	28.1/37.1
E3-5-M2-55	Heavy duty	14#	2	5	5	5	4.6	0.7-2	5	5500	495x355x545	28.1/37.1
E3-5x2-56	Extra Heavy Duty	19#	2	5	5	6	5	0.7-2	5	5500	495x355x545	28.1/37.1

JK-797TDI

Small Cylinder-bed Variable Top Feed Power Saving Overlock Machine



Power saving, Small cylinder, Variable top feed

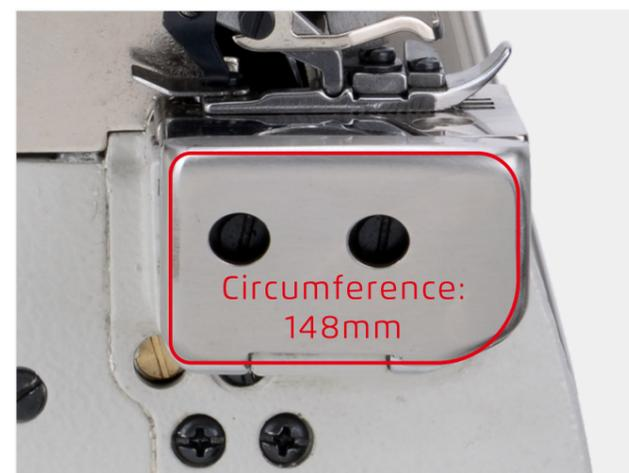

148mm cylinder bed



Differential feeding, Avoid of layers offset



Automatic extension device, Stable and high efficiency



One machine with multifunctions

Model	Needle	Needle No.	Thread No.	Needle Distance (mm)	Stitch width (mm)	Stitch Length (mm)	Differential Ratio	Presser Foot Lifting Height (mm)	Max. Speed (S.p.m)	Volume (mm)	Weight (kg)
JK-797TDI-3-504-02/233N	DCx27 11#	1	3	-	4	3.8	0.8-1.8	5	7000	525X360X510	28/36
JK-797TDI-4-514-M03/333	DCx27 11#	2	4	2	4	3.8	0.8-1.8	5.5	7000	525X360X510	28/36
JK-797TDI-4-514-M03/333/FR01	DCx27 11#	2	4	2	4	3.8	0.8-1.8	5.5	7000	525X360X630	28/36
JK-797TDI-4-514-M03/333/FR02	DCx27 11#	2	4	2	4	3.8	0.8-1.8	5.5	7000	525X360X630	28/40
JK-797TDI-4-514-M03/333/KS/FR01	DCx27 11#	2	4	2	4	3.8	0.8-1.8	5.5	7000	525X360X630	28/39
JK-797TDI-4-514-M03/333/KS/FR02	DCx27 11#	2	4	2	4	3.8	0.8-1.8	5.5	7000	525X360X630	28/43
JK-797TDI-4-514-M03/333/KS/FR05	DCx27 11#	2	4	2	4	3.8	0.8-1.8	5.5	7000	525X360X630	28/43
JK-797TDI-4-514-M03/333/KS/FR06	DCx27 11#	2	4	2	4	3.8	0.8-1.8	5.5	7000	525X360X630	28/43
JK-797TDI-4-514-M03/333/KS/FR09	DCx27 11#	2	4	2	4	3.8	0.8-1.8	5.5	7000	525X360X630	28/43

Note: 1. The parameters of small cylinder bed JK-797DI series are the same with above parameters.
2. KS: pneumatic type (verticl), FR01: Pneumatic extension device; FR02: Mechanical extension device; FR05: Mechanical position adjustment, pneumatic extension device; FR06: Automatic position adjustment, pneumatic extension device; FR09: Fully automatic feeding, position adjustment, pneumatic extension device.

JK-798TE

Variable Top Feed Computerized Overlock Machine



Variable top feed, 798TE: automatic, 798TDI: power saving



Auto thread trimming



Easy to adjust differential ratio



100% safety device

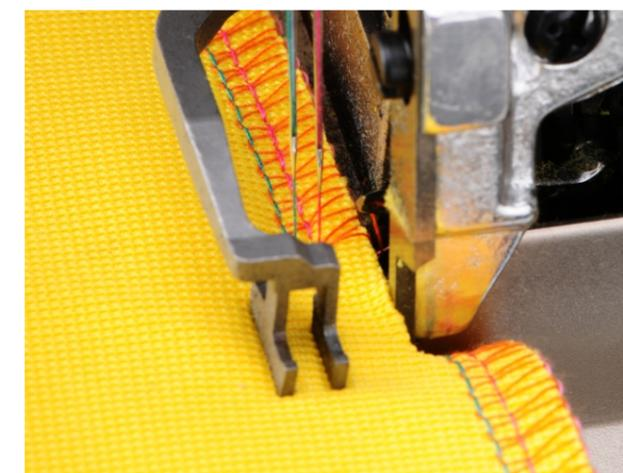

Differential feeding, Avoid of layers offset

Model	Functions	Needle	Needle No.	Thread No.	Needle Distance (mm)	Stitch Width (mm)	Stitch Length (mm)	Differential Ratio	Presser Foot Lifting Height (mm)	Max. Speed (S.p.m)	Volume (mm)	Weight (kg)
JK-798TE-4-514-M03/333	Plain Seaming	DCx27 11#	2	4	2	4	4.6	0.7-2	5.5	7000	505x360x565	29.2/39.8
JK-798TE-4-514-A04/435	Extra Heavy Duty	DCx27 14#	2	4	2	4	7	0.8-1.5	6	6500	505x360x565	29.2/39.8
JK-798TE-5-516-M03/333	3x4 Stitch	DCx27 14#	2	5	3	4	4	0.7-2	5	7000	505x360x565	29.2/39.8
JK-798TE-5-516-M03/233	5x5 Stitch	DCx27 14#	2	5	5	5	4	0.7-2	5	7000	505x360x565	29.2/39.8
JK-798TE-5-516-A04/435	Extra Heavy Duty	DCx27 19#	2	5	5	6	5	0.8-1.5	7	6500	505x360x565	29.2/39.8

Note: super high speed direct drive overlock with differential ratio: JK-798TDI series.

Overlock Process Device



Pocket Binding Seaming



C5-02X250

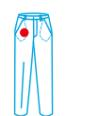
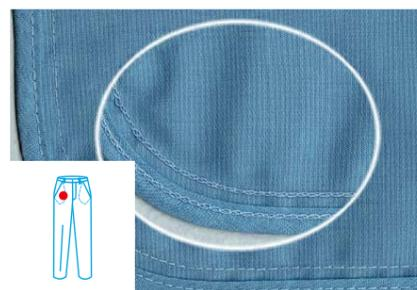

Tape Attaching Seaming



C5-5-53/233

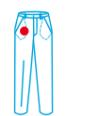
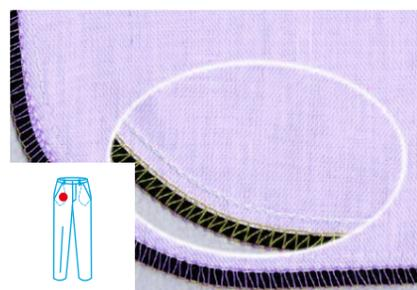

Towel Ending



C5MJ-4-53/233



Non-woven Material



C5WF-3-02/213



Rear Puller + Elastic Attaching Device



Rear Puller



Elastic Attaching Device



FR01 Pneumatic Extension Device



FR02 Mechanical Extension Device



FR06 Automatic Position Adjustment, Pneumatic Extension Device



FR09 Fully Automatic Feeding, Position Adjustment, Pneumatic Extension Device

Overlock Process/Stitches Table

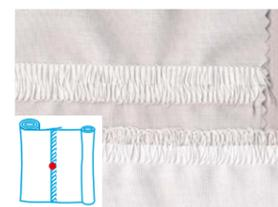

Fabric Joint Sewing
E45-2

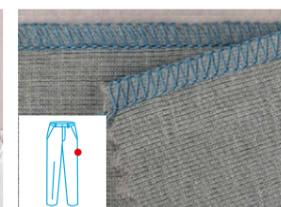

Three Threads Basic Stitch
C5-3-02/233

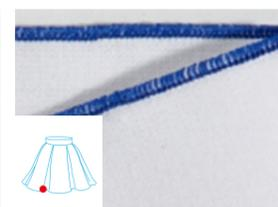

Three Threads Condense Seaming
C5-3-32R2/223



Three Threads Pneumatic Back Latch Seaming
C5S-3-82/233/BK



Four Threads Pneumatic Back Latch Seaming
C5S-4-83/323/BK

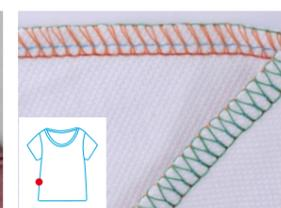

Four Threads Basic Stitch
C5-4-M03/333



Five Threads Basic Stitch (5X5)
C5-5-03/233

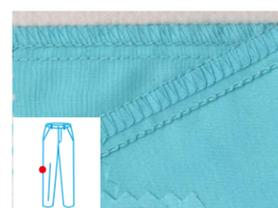

Five Threads Basic Stitch (3X4)
C5-5-03/333



Five Threads Heavy Duty Stitch
C5-5-M04/435



Six Threads Basic Stitch
C5-6-03/333



Six Threads Denim Stitch
C5-6-M04/435

Make the service smarter

Smart service is not only helping you to develop one quick-responding technician team, but also making the technician resources sharing possible by intelligent interaction platform.



Interlock Machine Series

K5E

Super high speed computerized cylinder bed interlock with stepping motor system



Low sound, high efficiency, stable performance

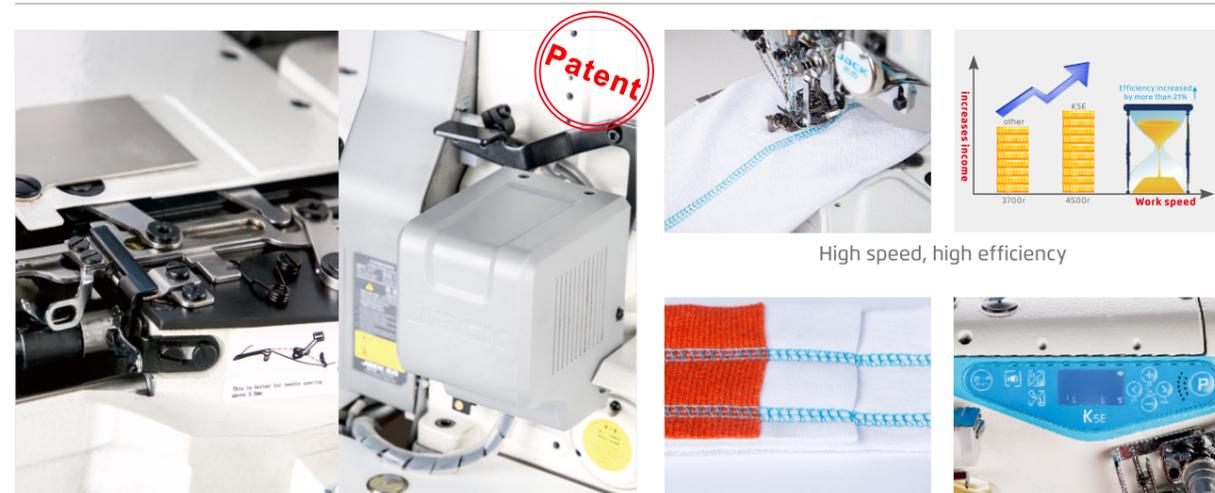

Precise trimming ,long life ,low sound

Wide adaptability of fabric

One-key reset, easy operation

Model	Needle	Needle No.	Thread No.	Stitch Width (mm)	Stitch Length (mm)	Differential Ratio	Presser Foot Lifting Height (mm)	Max. Speed (s.p.m)	Volume (mm)	Weight (kg)
K5E-UT-01GB	UY128GAS 11-14#	3	5	1.5-4.5	5.6/6.4	0.8-1.3	7	5500	670×445×595	52/62
K5E-UT-02BB	UY128GAS 11-14#	3	5	1.5-4.5	5.6/6.4	0.8-1.3	7	5500	670×445×595	52/62
K5E-UT-03GB	UY128GAS 11-14#	3	5	1.5-4.5	5.6/6.4	0.8-1.3	7	5500	670×445×595	52/62
K5E-UT-08AC	UY128GAS 11-14#	3	5	1.5-4.5	5.6/6.4	0.8-1.3	7	5500	670×445×595	52/62
K5E-UT-35AC	UY128GAS 11-14#	3	5	1.5-4.5	5.6/6.4	0.8-1.3	7	5000	670×445×720	53/65

Note:
1.UT: computerized machine, standard: with thread wiper, without upper thread trimmer D: direct drive .

K5

Super High Speed Computerized Cylinder-bed Interlock Machine



High Speed, Stable, High output

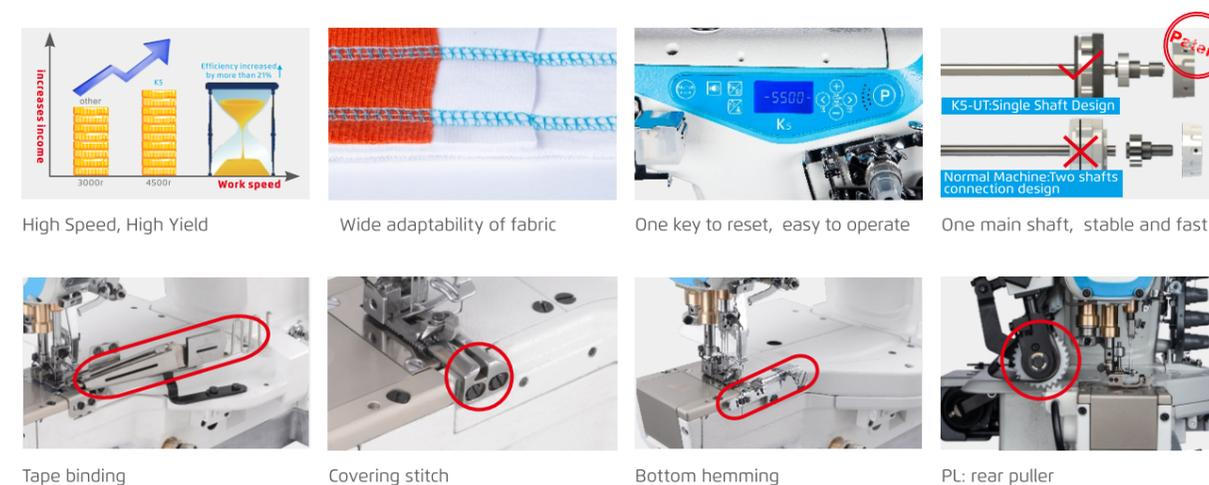

High Speed, High Yield

Wide adaptability of fabric

One key to reset, easy to operate

One main shaft, stable and fast

Tape binding

Covering stitch

Bottom hemming

PL: rear puller

Model	Needle	Needle No.	Thread No.	Stitch Width (mm)	Needle Gauge (mm)	Differential Ratio	Presser Foot Lifting Height (mm)	Max. Speed (s.p.m)	Volume (mm)	Weight (kg)
K5-UT-01GB	UT128GAS 11-14#	3	5	1.5-4.5	5.6/6.4	0.8-1.3	7	5500	670×445×595	52/62
K5-UT-02GB	UT128GAS 11-14#	3	5	1.5-4.5	5.6/6.4	0.8-1.3	7	5500	670×445×595	52/62
K5-UT-03GB	UT128GAS 11-14#	3	5	1.5-4.5	5.6/6.4	0.8-1.3	7	5500	670×445×595	52/62
K5-UT-08AC	UT128GAS 11-14#	3	5	1.5-4.5	5.6/6.4	0.8-1.3	7	5500	670×445×595	52/62
K5-UT-35AC	UT128GAS 11-14#	3	5	1.5-4.5	5.6/6.4	0.8-1.3	7	5500	670×445×720	53/62
K5-D-01GB	UT128GAS 11-14#	3	5	1.5-4.5	5.6/6.4	0.8-1.3	7	5500	670×445×595	46/56
K5-D-02BB	UT128GAS 11-14#	3	5	1.5-4.5	5.6/6.4	0.8-1.3	7	5500	670×445×595	46/56
K5-D-03GB	UT128GAS 11-14#	3	5	1.5-4.5	5.6/6.4	0.8-1.3	7	5500	670×445×595	46/56
K5-D-08AC	UT128GAS 11-14#	3	5	1.5-4.5	5.6/6.4	0.8-1.3	7	5500	670×445×595	46/56
K5-D-35AC	UT128GAS 11-14#	3	5	1.5-4.5	5.6/6.4	0.8-1.3	7	5500	670×445×720	47/59

Note:
1.UT: computerized machine, standard: with thread wiper, without upper thread trimmer D: direct drive .
2.UT type computerized machine is optional, standard: with thread wiper and upper thread trimmer; UTL pneumatic type computerized is optional (pneumatic thread trimming+ pneumatic foot lifter presser).

W4

High Speed Computerized Flat-bed Interlock Machine

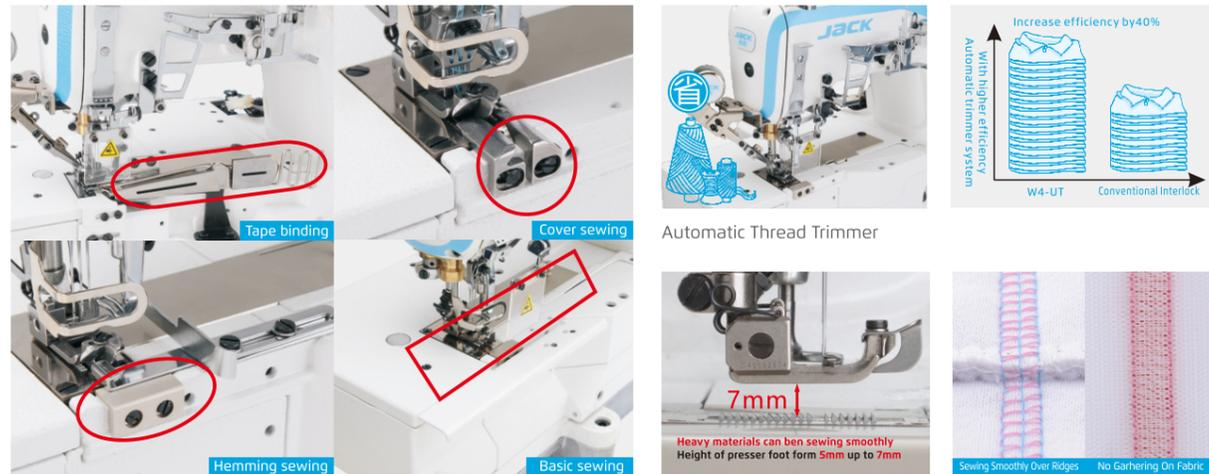

One Machine Multi-functions, Wide Application

For Light and Heavy Fabric, Beautiful Stitches

Model	Functions	Needle	Needle No.	Thread No.	Stitch Length (mm)	Stitch Width (mm)	Differential Ratio	Presser Foot Lifting Height (mm)	Max. Speed (s.p.m)	Volume (mm)	Weight (kg)
W4-UT-01GB	Plain Seaming	UY128GAS 11-14#	3	5	1.5-4.5	5.6/6.4	0.65-1.3	7	5500	670×445×595	54/64
W4-UT-02BB	Tape Binding	UY128GAS 11-14#	3	5	1.5-4.5	5.6/6.4	0.65-1.3	6	5500	670×445×595	54/64
W4-UT-03DB	Covering Stitch	UY128GAS 11-14#	3	5	1.5-4.5	5.6/6.4	0.65-1.3	7	5500	670×445×595	54/64
W4-UT-08AC	Bottom Hemming	UY128GAS 11-14#	3	5	1.5-4.5	5.6/6.4	0.65-1.3	7	5500	670×445×595	54/64
W4-D-01GB	Plain Seaming	UY128GAS 11-14#	3	5	1.5-4.5	5.6/6.4	0.65-1.3	7	5500	670×445×595	48/58
W4-D-02BB	Tape Binding	UY128GAS 11-14#	3	5	1.5-4.5	5.6/6.4	0.65-1.3	6	5500	670×445×595	48/58
W4-D-03DB	Covering Stitch	UY128GAS 11-14#	3	5	1.5-4.5	5.6/6.4	0.65-1.3	7	5500	670×445×595	48/58
W4-D-05CB	Elastic Lace Attaching (Right-Side Cutter)	UY128GAS 11-14#	3	5	1.5-4.5	5.6/6.4	0.65-1.3	6	4000	670×445×595	48/58
W4-D-07CB	Elastic Lace Attaching	UY128GAS 11-14#	3	5	1.5-4.5	5.6/6.4	0.65-1.3	7	5500	670×445×595	48/58
W4-D-08AC	Bottom Hemming	UY128GAS 11-14#	3	5	1.5-4.5	5.6/6.4	0.65-1.3	7	5500	670×445×595	48/58
W4-D-23GB	Plain Seaming (large Stitch Length)	UY128GAS 11-14#	3	5	6	5.6/6.4	0.65-1	7	4000	670×445×595	48/58
W4-D-23BB	Tape Binding (Large Stitch Length)	UY128GAS 11-14#	3	5	6	5.6/6.4	0.65-1	7	4000	670×445×595	48/58
W4-D-23GBL	Plain Seaming (Extra Large Stitch Length)	UY128GAS 11-14#	2	4	7-7.5	5.6/6.4	1	7	4000	670×445×595	48/58
W4-D-23BBL	Tape Binding (Extra Large Stitch Length)	UY128GAS 11-14#	2	4	7-7.5	5.6/6.4	1	7	4000	670×445×595	48/58

Note: UT2: computerized, D:direct drive.

JK-8670BDII-UT

High Speed Computerized Small Cylinder-bed Interlock Machine

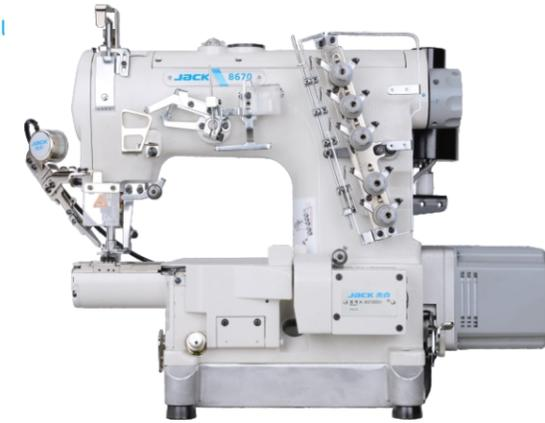

Small Cylinder, Full-automatic



Auto thread trimming

Out-moved thread cam

Cooling fan

Small cylinder

Model	Functions	Needle	Needle No.	Thread No.	Stitch Length (mm)	Stitch Width (mm)	Differential Ratio	Presser Foot Lifting Height (mm)	Max. Speed (S.p.m)	Volume (mm)	Weight (kg)
JK-8670BDII-01CB/UT	Plain Seaming	UY128GAS 11-14#	3	5	1.5-3.6	5.6/6.4	0.8-1.4	6.2	4500	680×420×630	50/60
JK-8670BDII-03FB/UT	Covering Stitch(Flattening out)	UY128GAS 11-14#	3	5	1.5-3.6	5.6/6.4	0.8-1.4	6.2	4500	680×420×630	50/60
JK-8670BDII-03GB/UT	Covering Stitch(Folding over)	UY128GAS 11-14#	3	5	1.5-3.6	5.6/6.4	0.8-1.4	6.2	4500	680×420×630	50/60
JK-8670BDII-08AC/UT	Bottom Hemming(Narrow)	UY128GAS 11-14#	3	5	1.5-3.6	5.6/6.4	0.8-1.4	6.2	4500	680×420×630	50/60
JK-8670BDII-08BC/UT	Bottom Hemming(Wide)	UY128GAS 11-14#	3	5	1.5-3.6	5.6/6.4	0.8-1.4	6.2	4500	680×420×630	50/60
JK-8670BDI-01CB	Plain Seaming	UY128GAS 11-14#	3	5	1.5-3.6	5.6/6.4	0.8-1.4	6.2	4500	630×390×630	42/54
JK-8670BDI-03FB	Covering Stitch	UY128GAS 11-14#	3	5	1.5-3.6	5.6/6.4	0.8-1.4	6.2	4500	630×390×630	42/54
JK-8670BDI-03GB	Covering Stitch	UY128GAS 11-14#	3	5	1.5-3.6	5.6/6.4	0.8-1.4	6.2	4500	630×390×630	42/54
JK-8670BDI-08AC	Bottom Hemming(Narrow)	UY128GAS 11-14#	3	5	1.5-3.6	5.6/6.4	0.8-1.4	6.2	4500	630×390×630	42/54
JK-8670BDI-08BC	Bottom Hemming(Wide)	UY128GAS 11-14#	3	5	1.5-3.6	5.6/6.4	0.8-1.4	6.2	4500	630×390×630	42/54

Note: UT: computerized, D: direct drive.

JK-8009VCDII/UTL

High Speed Computerized
Multi-needle Machine

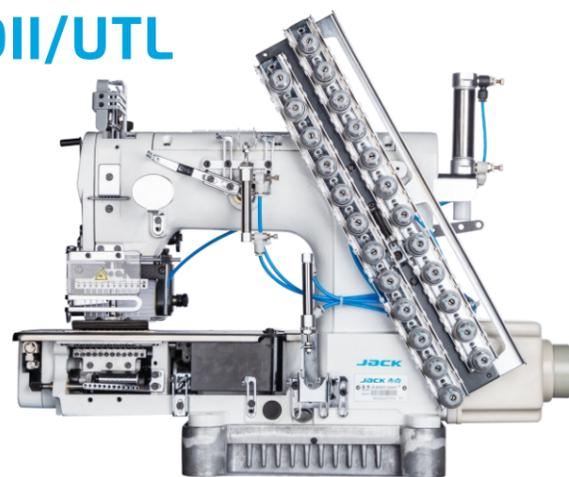

Power-saving, Wide Applications



Elastic attaching



Tape attaching



Shirt-fronting



Waist band JK-8009HF

Model	Needle	Needle No.	Thread No.	Stitch Length (mm)	Stitch Width (mm)	Presser Foot Lifting Height (mm)	Max. Speed (S.p.m)	Volume (mm)	Weight (kg)
JK-8009VCDII-04064P/04080P/04085P/04095P/UTL	U0113 14-16#	4	8	1.7-4.0	6.4/7.9/8.7/9.5	8	3500	615×400×605	52.5/57.5
JK-8009VCDII-06048P /06064P /06080P/06095P/UTL	U0113 14-16#	6	12	1.7-4.0	6.4/7.9/9.5	8	3500	615×400×605	52.5/57.5
JK-8009VCDII-08064P/08085P /UTL	U0113 14-16#	8	16	1.7-4.0	6.4/8.7	8	3500	615×400×605	52.5/57.5
JK-8009VCDII-12064P /UTL	U0113 14-16#	12	24	1.7-4.0	6.4	8	3500	615×400×605	52.5/57.5
JK-8009VCDII-13064-32P /UTL	U0113 14-16#	13	26	1.7-4.0	6.4	8	3500	615×400×605	52.5/57.5
JK-8009HF-04064-254P	TV×5 19-21#	4	8	1.7-4.0	6.4-25.4-6.4	8	3500	615×400×605	52.5/57.5
JK-8009VCDI-04064P/04080P /04085P/04095P	U0113 14-16#	4	8	1.7-4.0	6.4/7.9/8.7/9.5	8	3500	615×400×605	52.5/57.5
JK-8009VCDI-06048P/06064P /06080P/06095P	U0113 14-16#	6	12	1.7-4.0	4.8/6.4/7.9/9.5	8	3500	615×400×605	52.5/57.5
JK-8009VCDI-08032P/08048P /08064P/08085P	U0113 14-16#	8	16	1.7-4.0	3.2/4.8/6.4/8.7	8	3500	615×400×605	52.5/57.5
JK-8009VCDI-12032P/12048P /12064P	U0113 14-16#	12	24	1.7-4.0	3.2/4.8/6.4	8	3500	615×400×605	52.5/57.5
JK-8009VCDI-13064-32P	U0113 14-16#	13	26	1.7-4.0	6.4-3.2	8	3500	615×400×605	52.5/57.5
JK-8009VCDI-17032P	U0113 14-16#	17	34	1.7-4.0	3.2	8	3500	615×400×605	52.5/57.5
JK-8009VCDI-23032P	U0113 14-16#	23	46	1.7-4.0	3.2	8	3500	615×400×605	52.5/57.5
JK-8009VCDI-25032P	U0113 14-16#	25	50	1.7-4.0	3.2	8	3500	615×400×605	52.5/57.5

Optional device:

UT: computerized, D: direct drive.

P (gear puller), PR (flat puller), VWL (front elastic feeding), VPL (tape attaching), VSF (shirt fronting), VPQ (elastic thread shirring).

JK-8740-460-02/D/AW/S

4 Needles 6 Thread Feed-off-arm Interlock Machine

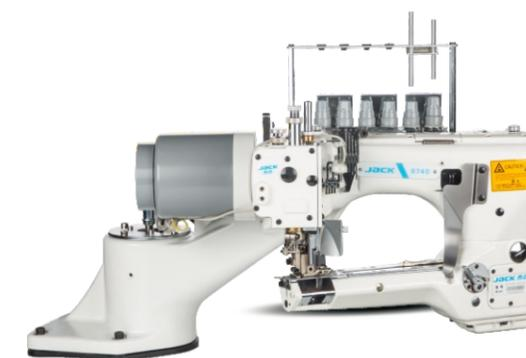

High Efficiency, Good Quality, Easy to Use

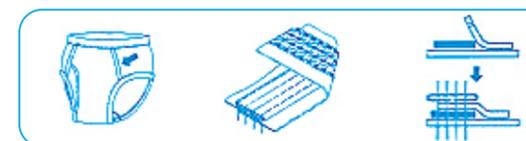

Large Operating Space Design

Model	Needles	Stitches	Stitch Width (mm)	Stitch Length (mm)	Differential Ratio	Presser Foot Height(mm)	Needle Distance(mm)	Speed (S.p.m)	Optional Device	Suction Device	Procedure
JK-8740-01	4	6	4.8 5.2 6.0	1.6-2.5	1:0.7-1:0.5	6-8	30	3200	D UT UTL	AW1L AW1S AW2L AW2S	S DS T1 T2
JK-8740-02	4	6	6.4 7.0 8.0	1.6-2.5	1:0.7-1:0.5	6-8	3200				
JK-8740-02H	4	6		1.6-2.5	1:0.7-1:0.5	6-8	3200				

JK-8787-01GX356/UT

Super High Speed Computerized
Cylinder-bed Interlock Machine

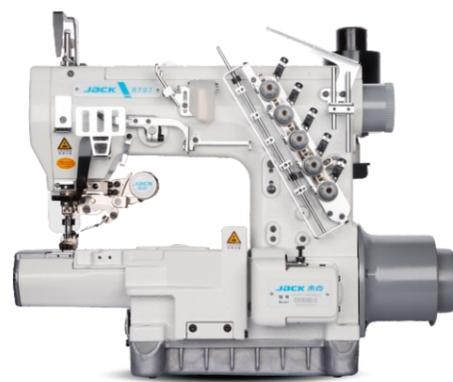

High Efficiency, Good Quality, Easy to Use



Bobbin Threading Improved



Electromagnetic Presser Foot Lifter

Model	Stitch	Thread	Stitch Length	Stitch Width (mm)	Presser foot Height(mm)	Differential Ratio	Speed (S.p.m)	Optional Device	Pulley
JK-8787-01GX356/UT	3	5	1.4-4.5	5.6	7	0.8-1.4	4500	D UT UT2 UTL	PL (gear wheel)
JK-8787-01GX354/UT	3	5	1.4-4.5	6.4	7	0.8-1.4	4500		
JK-8787-02BX356/D	3	5	1.4-4.5	5.6	7	0.8-1.4	4500		PR (Flat wheel)
JK-8787-02BX354/D	3	5	1.4-4.5	6.4	7	0.8-1.4	4500		

JK-8770-01GX356/UT

High Speed Computerized Small
Cylinder-bed Interlock Machine

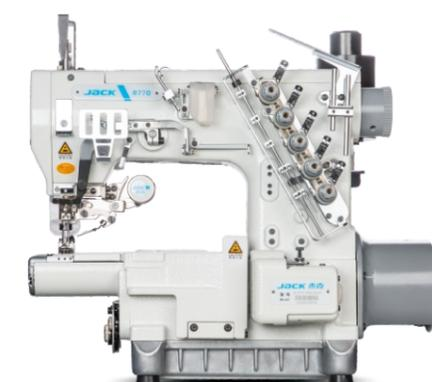

High Efficiency; Good Quality; Easy to Use



Front Type Bobbin Thread Divider



Mini Direct Drive Servo Motor

Model	Stitch	Thread	Stitch Length	Stitch Width (mm)	Presser Foot Height(mm)	Differential Ratio	Speed (S.p.m)	Optional Device
JK-8770-01GX356/UT	3	5	1.4-4.5	5.6	7	0.8-1.4	4200	D UT UT2 UTL
JK-8770-01GX356X/UT	3	5	1.4-4.5	6.4	7	0.8-1.4	4200	

Interlock Device and Stitches Table



Tape Binding

K5-UT-02BB

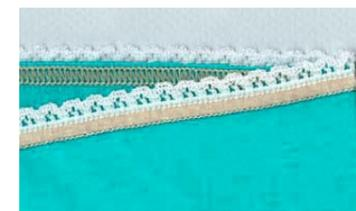
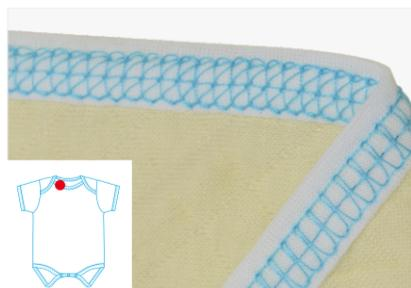

W4-D-05CB
Elastic Lace Attaching
(Right-side Cutter)

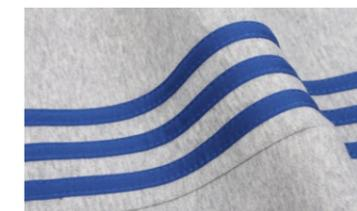

JK-8009VCDI/VPL
Tape Attaching

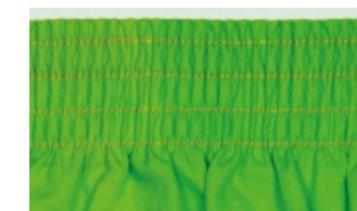

JK-8009VCDI/VWL
Elastic Attaching(Pants)



Covering Stitch

K5-D-03GB



JK-8009VCDI/VSF
Placket Seaming (Shirt)



JK-8009VCDI/VPQ
Simultaneous shirring



JK-8009HF
Waist Seaming (Jeans)



Bottom Hemming

K5-UT-08AC

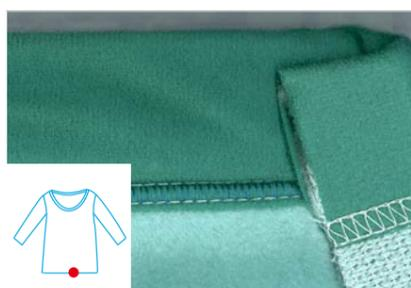

Device for Wide Sewing Bed



Four in One Sewing Bed



Rear Puller Device



Bottom Hemming (Left-side Cutter)

K5-UT-35AC





Special Machine Series

MX-100A

360 Degree Needle Bar Rotation
Template Sewing Machine



No reverse stitch, Perfect quality

MS-100A

Super Large Sewing Area Template Machine

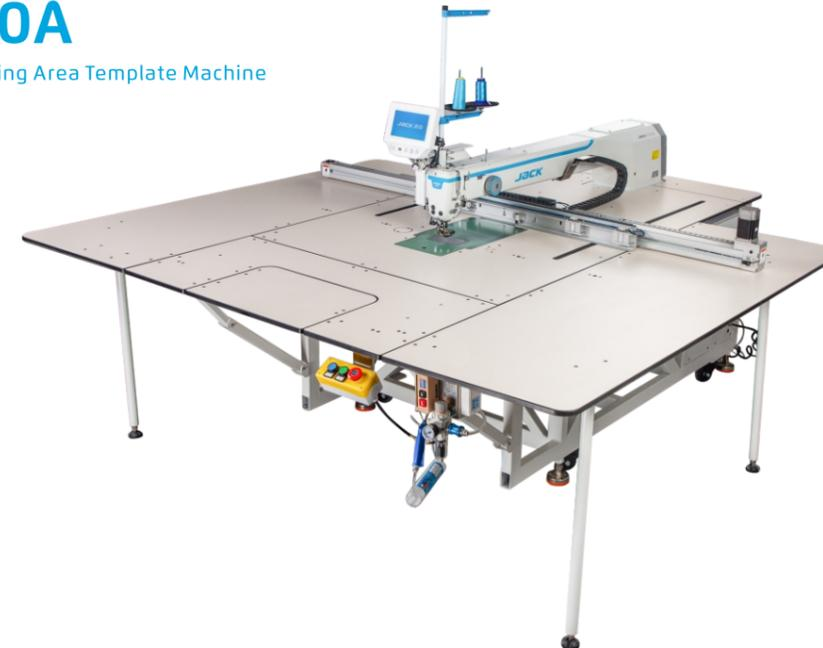

Large Sewing Area, Super Stable



No Reverse Stitch, Perfect Quality



Germany design

Germany Design



Super Large Sewing Area

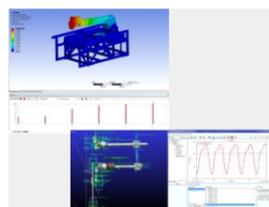

Low Noise, Low Vibration



Shifted Folding Table, Easy To Assemble&transfer



Electronic Tension Post Function



Shifted Folding Table, Easy To Assemble&transfer



Super Large Sewing Area



Smart Plate Recognition, Save Power



Germany New Design, Brand New Face

Model	Purpose	Needle	Needle No.	Thread No.	Sewing Area (mm)	Middle Presser Foot Height (mm)	Needle Gauge (mm)	Max.Speed (S.p.m)	Volume (mm)	Weight (kg)
MX-100A+-955YX-F13 (Two directions screw drive)	Plate sewing	DPx5 DPx17	1	2	1400x950	15	1-12.7	2800	2350x1340x1535	742/845
MX-100A+-955TYX-F13 (One direction screw drive)	Plate sewing	DPx5 DPx17	1	2	1400x950	15	1-12.7	2800	2350x1340x1535	742/845

Note: standard IOT function; standard F13 bottom thread detection,
Alternative device--F16: pointing device, F17: laser purifying device, F11A: laser cutting device, F11B: high power laser cutting device

Model	Purpose	Needle	Needle No.	Thread No.	Sewing Area (mm)	Middle Presser Foot Walking Distance (mm)	Needle Gauge (mm)	Max.Speed (S.p.m)	Volume (mm)	Weight (kg)
MS-100A+-95TYX-F13 (Big hook, One direction screw drive)	Plate sewing	DPx5 DPx17	1	2	1400x950	15	0.1-20	3000	2150x1310x1350	662/742
MS-100AP+-95TYX-F13 (Small hook, One direction screw drive)	Plate sewing	DPx5 DPx17	1	2	1400x950	15	0.1-20	3000	2150x1310x1350	662/742
MS-100A+-955YX-F13 (Big hook, Double direction screw drive)	Plate sewing	DPx5 DPx17	1	2	1400x950	15	0.1-20	3000	2150x1310x1350	662/742
MS-100AP+-955YX-F13 (Small hook, Double direction screw drive)	Plate sewing	DPx5 DPx17	1	2	1400x950	15	0.1-20	3000	2150x1310x1350	662/742

Note: standard IOT function; standard F13 bottom thread detection;
Alternative device--F16: pointing device, F17: laser purifying device, F11A: laser cutting device, F11B: high power laser cutting device

MG-80A

Intelligent Template Machine



Wide Use, High Efficiency, Suitable For Ordinary Workstation



Small Footprint



Humanized Operation Panel



Smart Middle Presser Foot, Perfect Sewing

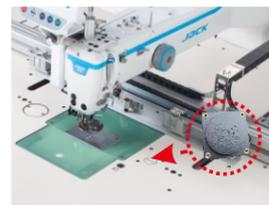

Higher Precision, Save Time & power

Model	Purpose	Needle	Needle No.	Thread No.	Sewing Area (mm)	Middle Presser Foot Height (mm)	Needle Gauge (mm)	Max.Speed (S.p.m)	Volume (mm)	Weight (kg)
MG-80AP-55TSYX	Plate sewing	DP×5 DP×17	1	2	800×550	15	1-5	3200	16200×1350×1305	320/395

Noted: IOT function is alternative, F13: bottom thread detection function, F16: pointing device, F17: laser purification device, F11A: laser cutting device

MS-90A

Intelligent Large-area Template Sewing Machine



Polytechnic, Easy Operation, Stabilization



Moving Stable, Low Vibrati



Folding Sewing Table, Easy To Install



Various Big Presser Foot, Wide Range Of Application



Pattern Recognition

Model	Needle	Stitch No.	Thread No.	Sewing Rang (mm)	Presser Foot Lifting Height (mm)	Stitch Length (mm)	Max. Speed (s.p.m)	Volume (mm)	Weight (kg)
MS-90A-80S (double screw drive)	DP×5 8-16#	1	2	1400×800	15	1-5	3000	2440×1340×1420	727/860
MS-90A-81T (one screw drive)	DP×5 8-16#	1	2	1400×810	15	1-5	3000	2440×1340×1420	727/860
MT-90C-83T (double belt drive)	DP×5 8-16#	1	2	1400×830	15	1-5	3000	2160×1100×1350	527/620

Note: Optional: F10 is Auto-bobbin Change F11 is leaser cutting; F16 is draw point; F17 is leaser cutting suction

MG-60A

Flexible Size Template Sewing Machine



Flexible Size, multi Function, high Efficiency

Programmable Electronic Pattern Sewing Machine Series



Full-automatic, Programmable, High Efficiency

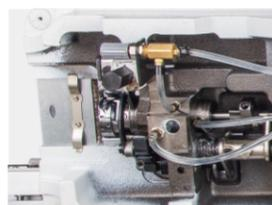

Double Moving Knife



Intelligent Middle Presser Foot, Beautiful Stitch



Flexible Size, Easy To Adapt Different Process



Pattern Recognition

Model	Needle	Needle No.	Stitch length (mm)	Presser Foot Lifting Height (mm)	Max. Speed (s.p.m)	Sewing Range (mm)	Volume (mm)	Weight (kg)
MG-60A-40TSYX	D Bx17-14#	1	1-5	12	3300	600x400	1650x1420x1325	260/320



Intelligent central presser foot



For heavy duty



Wide range of application



Visual operation

Model	Optional Device	Needle	Stitch No.	Thread No.	Sewing Rang (mm)	Presser Foot Lifting Height (mm)	Max. Speed (s.p.m)	Volume (mm)	Weight (kg)
JK-T1310	F1	DPx17 11-25#	1	2	130x100	22	2700	1220x840x1320	140/184 140/189(Reinforce)
JK-T2210	F1,F3,K	DPx17 11-25#	1	2	200x100	22	2700	1220x840x1320	142/186 142/191(Reinforce)
JK-T3020	F4,K,TDB	DPx17 11-25#	1	2	300x200	22	2700	1220x1220x1320	216/280 216/293(Reinforce)
JK-T6040	-	DPx17 11-25#	1	2	600x400	22	2500	1920x1620x1420	347/480 347/508(Reinforce)
JK-T10040	-	DPx17 11-25#	1	2	1000x400	22	2500	1920x1620x1420	367/500 367/528(Reinforce)

Note: 1. F1: flip presser foot, F3-2210sideslip presser foot, F4-3020sideslip presser foot, K: clamping device, TDB: pocket attaching.
2. factory standard machine needle DPX17 19#.
3. F1 F2 F3 F4 TDB equipment sewing range subject to actual.

JK-T5878-68B/78

Automatic Pocket Welting Machine



Full-automatic, High Efficiency

JK-T5878-58G

Automatic Placket Setting Machine



Full-automatic, High Efficiency



For different kinds of pocket

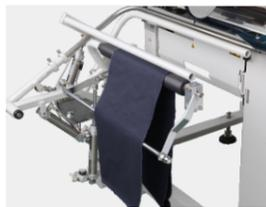

Automatic collective device

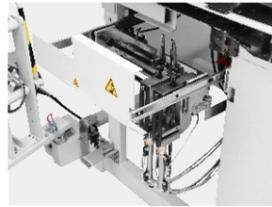

High output

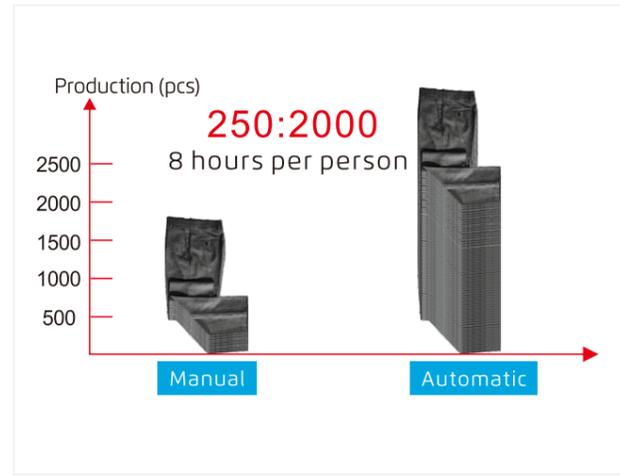

Easy to adjust, Precisely cutting

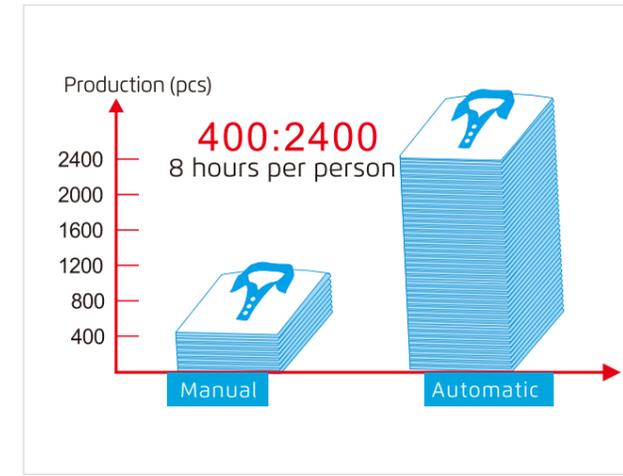

High output



For different kinds of placket



Automatic collective

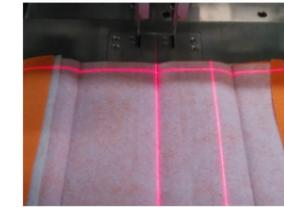

Laser positioning

Model	Application	Needle	Stitch No.	Thread No.	Needle Gauge (mm)	Pocket Size (mm)	Max. Speed (s.p.m)	Volume (mm)	Weight (kg)
JK-T5878-68B	Straight Pocket	Mtx190 14#-18#	2	3	8-20	18-220	3000	1600×1100×1500	240/350
JK-T5878-78	Slant Pocket	DPx17 14#-18#	2	3	8-20	18-220	3000	1600×1100×1500	240/350

Model	Application	Needle	Stitch No.	Thread No.	Sewing Width (mm)	Sewing Length (mm)	Max. Speed (s.p.m)	Volume (mm)	Weight (kg)
JK-T5878-58G	T-shirt Placket	DBX111#	1	2	1-50	15-260	4000	2050×1050×1580	258/350

JK-T9270D/9280D

Direct Drive Feed-off-the Arm Machine

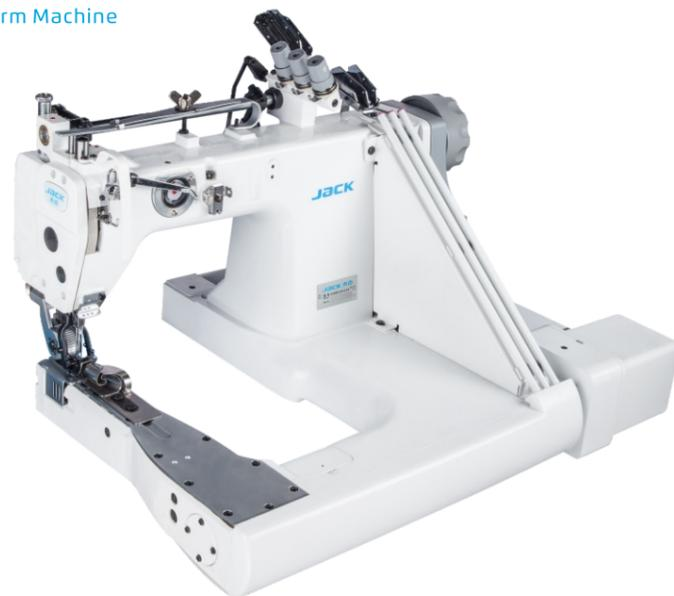

Mechatronic Wildely Using



Automatic Needle stopping

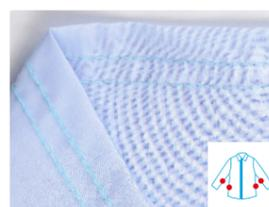

Double Needle Feed-off-arm Machine



Integrated, Power Saving

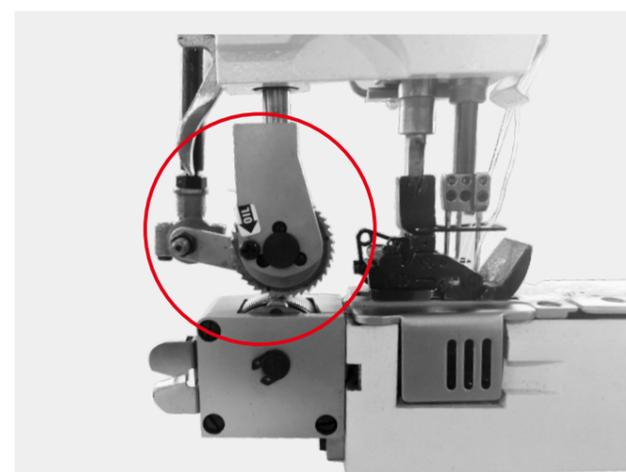

Rear Puller lubricated design

Model	Needle Gauge	Needle	Stitch No.	Thread No.	Needle Gauge (mm)	Presser Foot Lifting Height (mm)	Light Material	Medium Material	Heavy Duty	Heavier Duty	Max. Speed (mm)	Volume (mm)	Weight (kg)
JK-T9270D-12-Q	1/4,3/16	TV×64 12#	2	4	3.5	8	✓				3500	685×535×475	61.5/68.5
JK-T9270D-12-2PL-Q	1/4,3/16	TV×64 12#	2	4	3.5	8	✓				3500	685×535×475	61.5/68.5
JK-T9270D-12-2PS-Q	1/4,3/16	TV×64 12#	2	4	3.5	8	✓				3500	685×535×475	61.5/68.5
JK-T9270D-12-2PL-Q (for raincoat)	3/16	TV×64 12#	2	4	4.2	8	✓				3500	685×535×475	61.5/68.5
JK-T9270D-13-Q	1/8	TV×64 12#	3	6	3.5	8	✓				3500	685×535×475	61.5/68.5
JK-T9270D-13-2PL-Q	1/8	TV×64 12#	3	6	3.5	8	✓				3500	685×535×475	61.5/68.5
JK-T9270D-22-Q	1/4,3/16	TV×64 14#	2	4	3.5	8		✓			3500	685×535×475	61.5/68.5
JK-T9280D-53-Q	1/8	TV×5 21#	3	6	4.2	10			✓		3000	685×535×475	61.5/68.5
JK-T9280D-73-2PL-Q	1/8	TV×5 21#	3	6	4.2	10				✓	3000	685×535×475	61.5/68.5
JK-T9280D-73-PL-Q	1/8	TV×5 21#	3	6	4.2	10				✓	3000	685×535×475	61.5/68.5
JK-T9280D-73-PS-Q	1/8	TV×5 21#	3	6	4.2	10				✓	3000	685×535×475	61.5/68.5

Note: PL: rear puller; PS: box puller; JK-T9270D-12-2PL-Q needle gauge is 4.2mm for sewing raincoats.

Special Machine Series | 47

JK-T1900G

Thread Cleanness High Speed Electronic bartacking & Button Attaching Machine

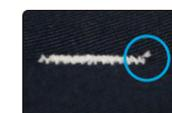

Short Thread Remaining



Normal Thread Remaining



One Machine, Multi Functions, Highefficiency, Short Thread Remaining



Simple and Intuitive, Easy to Operate



One Machine, Multi Functions



One Machine, Multi Functions



Cap hole Fishing nets

Model	application	Needle	Needle No.	Thread No.	Sewing range (X) (mm)	Sewing range (Y) (mm)	Presser Foot Lifting Height (mm)	Max. Speed (s.p.m)	Volume (mm)	Weight (kg)
JK-T1900GSK	Light and Middle Fabric	DP×5 16#	1	2	40	30	13	3200	805×405×525	55/64
JK-T1900GS	Light and Middle Fabric	DP×5 16#	1	2	40	30	13	3200	805×405×525	55/64
JK-T1900GHK	Heavy Fabric	DP×17 19#	1	2	40	30	13	2700	805×405×525	55/64
JK-T1900GH	Heavy Fabric	DP×17 19#	1	2	40	30	13	2700	805×405×525	55/64
JK-T1900GSXK	Short Thread Remaining	DP×5 16#	1	2	40	30	13	3200	805×405×525	55/64
JK-T1900GMK	Knitted Fabric	DP×5 11#	1	2	40	30	13	2700	805×405×525	55/64
JK-T1900GM	Knitted Fabric	DP×5 11#	1	2	40	30	13	2700	805×405×525	55/64
JK-T1900GY	Cap Hole	DP×5 16#	1	2	40	30	13	2700	805×405×525	55/64
JK-T1900GN	Fishing Net	DP×17 19#	1	2	40	30	13	2300	805×405×525	55/64
JK-T1900GL	Socks Sewing	DP×17 14#	1	2	40	35	13	2000	805×405×525	55/64
JK-T1906GS	Pattern	DP×17 14#	1	2	60	50	10	2700	805×405×525	55/64
JK-T1906GP	Elastic Attaching	DP×17 14#	1	2	60	50	10	2700	805×405×525	55/64

Note: Auto presser foot lifter, auto trimmer, auto wipper are standards. K: Bartacking and Button attaching can be transferred easily. X is short thread remaining.

JK-T1903GR

Electronic Button Attaching Machine



Automatic Button Feeding High Efficiency

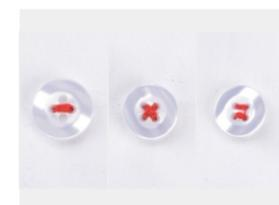

Wide range of application



Easy operation easy using



Pressure foot protection, safe and reliable



Automatic button feeding

Model	application	Needle	Needle No.	Thread No.	Button diameter (mm)	Button size (mm)	Presser Foot Lifting Height (mm)	Max. Speed (s.p.m)	Volume (mm)	Weight (kg)
JK-T1903GSK	Basic Model	DP×17 14#	1	2	Φ8-Φ30	X:2.4-6.8 Y:2.4-6.8	10	2700	805×405×525	55/64
JK-T1903GR	Auto Button Feeding Device	DP×17 14#	1	2	Φ9-Φ22	X:2.4-6.8 Y:2.4-6.8	13	2700	1020×870×1390	131/177
JK-T1903GS	Button Attaching Machine	DP×17 14#	1	2	Φ8-Φ30	X:2.4-6.8 Y:2.4-6.8	10	2700	805×405×525	55/64

Note: Auto presser foot lifter, auto trimmer, auto wipper are standards. K:Bartacking and Button attaching can be transferred easily.

JK-T1790G

High Speed Electronic Lockstich Buttonholing Machine



Short Thread Remaining



Normal Thread Remaining



Intelligent Convenient High Efficiency

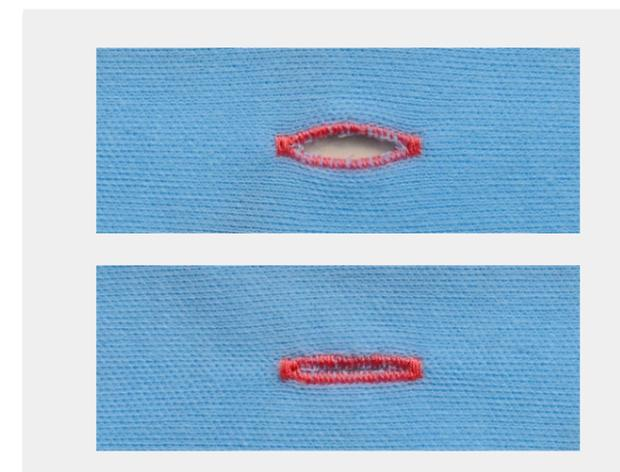

Basting stitch

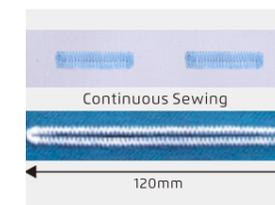

Continuously sewing (JK-T1790G)



Cutter driven by servo motor



Easy operation easy using

Model	Functions	Button Hole Size (mm)	Needle	Needle No.	Side Cutter Function	Thread No.	Parallel Interspace (mm)	Presser Foot Lifter Height (mm)	Max.Speed (s.p.m)	Volume (mm)	Weight (kg)
JK-T1790GS-1-D	Woven material	25×4	DP×5 12#	1	1/4"~3/4"	2	0.2-2.5	17	4200	880×390×635	66/78
JK-T1790GS-2-D	Woven material	35×5	DP×5 12#	1	1/4"~1"	2	0.2-2.5	17	4200	880×390×635	66/78
JK-T1790GS-3-D	Woven material	41×5	DP×5 12#	1	1/4"~1 1/4"	2	0.2-2.5	17	4200	880×390×635	66/78
JK-T1791GS-D	Woven material	70×5	DP×5 12#	1	1/4"~1 1/4"	2	0.2-2.5	17	4200	880×390×635	66/78
JK-T1792GS-D	Woven material	120×5	DP×5 12#	1	1/4"~1 1/4"	2	0.2-2.5	17	4200	880×390×635	66/78
JK-T1790GSX-1-D	Woven material	25×4	DP×5 12#	1	1/4"~3/4"	2	0.2-2.5	17	4200	880×390×635	66/78
JK-T1790GS-1-D-F13	Woven material	25×4	DP×5 12#	1	1/4"~3/4"	2	0.2-2.5	17	4200	880×390×635	66/78
JK-T1790GS-1-D [®]	Woven material	25×4	DP×5 12#	1	1/4"~3/4"	2	0.2-2.5	17	4200	880×390×635	66/78
JK-T1790GK-1-D	Knits material	25×4	DP×5KN 11#	1	1/4"~3/4"	2	0.2-2.5	17	4200	880×390×635	66/78
JK-T1790GK-2-D	Knits material	35×5	DP×5KN 11#	1	1/4"~1"	2	0.2-2.5	17	4200	880×390×635	66/78
JK-T1790GK-3-D	Knits material	41×5	DP×5KN 11#	1	1/4"~1 1/4"	2	0.2-2.5	17	4200	880×390×635	66/78
JK-T1791GK-D	Knits material	70×5	DP×5KN 11#	1	1/4"~1 1/4"	2	0.2-2.5	17	4200	880×390×635	66/78
JK-T1792GK-D	Knits material	120×5	DP×5KN 11#	1	1/4"~1 1/4"	2	0.2-2.5	17	4200	880×390×635	66/78
JK-T1790GK-1-D-F13	Knits material	25×4	DP×5KN 11#	1	1/4"~3/4"	2	0.2-2.5	17	4200	880×390×635	66/78
JK-T1790GK-1-D [®]	Knits material	25×4	DP×5KN 11#	1	1/4"~3/4"	2	0.2-2.5	17	4200	880×390×635	66/78

Noted:Standard with automatic lifting foot, automatic line cutting function; Short-end, Internet of Things and bottom line detection are optional functions

JK-T781G

New Integrated Electronic Lockstitch Buttonholding Machine



Auto Pressur Foot Lifter, Power Saving Efficiency



Power Saving And Efficient



Dot Screen, easy Operation



Wide Rang Of Applications, Beautiful Stitches



Short Thread Remaining, No Need Thread Timmer Again



Mechatronics, Easy To Install

Model	Functions	Button Hole Size (mm)	Needle DP×5	Needle No.	Side Cutter Function	Thread No.	Parallel Interspace (mm)	Automatic Thread Trimmer	Auto Presser Foot Lifter	Presser Foot Lifter Height (mm)	Max.Speed (S.p.m)	Volume (mm)	Weight (kg)
JK-T781G-Z	Woven material	22×4	DP×5	12#	1	1/4"~3/4"	2	0.2-2.5	✓	✓	12	730×365×695	46/66
JK-T782G-Z	Woven material	33×5	DP×5	12#	1	1/4"~1"	2	0.2-2.5	✓	✓	12	730×365×695	46/66
JK-T783G-Z	Woven material	40×5	DP×5	12#	1	1/4"~1 1/4"	2	0.2-2.5	✓	✓	12	730×365×695	46/66
JK-T781GK-Z	Knitting material	22×4	DP×5KN	11#	1	1/4"~3/4"	2	0.2-2.5	✓	✓	12	730×365×695	46/66
JK-T781GX-Z	Woven material	22×4	DP×5	12#	1	1/4"~3/4"	2	0.2-2.5	✓	✓	12	730×365×695	46/66
JK-T781G-Z-F13	Woven material	40×5	DP×5	12#	1	1/4"~1 1/4"	2	0.2-2.5	✓	✓	12	730×365×695	46/66
JK-T782G-Z-F13	Woven material	33×5	DP×5	12#	1	1/4"~1"	2	0.2-2.5	✓	✓	12	730×365×695	46/66
JK-T783G-Z-F13	Woven material	40×5	DP×5	12#	1	1/4"~1 1/4"	2	0.2-2.5	✓	✓	12	730×365×695	46/66
JK-T781GK-Z-F13	Knitting material	22×4	DP×5KN	11#	1	1/4"~3/4"	2	0.2-2.5	✓	✓	12	730×365×695	46/66
JK-T781GX-Z-F13	Woven material	22×4	DP×5	12#	1	1/4"~3/4"	2	0.2-2.5	✓	✓	12	730×365×695	46/66

Noted:X stand for short thread and suitable for woven shirt thin material.F13 stand for bottom thread detection,need to be used air source



JK-T1377E

Integrated Computerized Button Attaching Machine
Automatic, Easy Shift Efficiency



JK-T373E

Integrated Computerized Button Attaching Machine
Automatic Sewing, High Efficiency

JK-T1377E



Three Patterns



Integrated, Power Saving And Environmental Protection



Lcd Operation Panel, Easy To Use



Eccentric Wheel Optimization, Operation More Stable

Model	Needle	Stitch No.	Thread No.	Button Diameter (mm)	Button Hole Size (mm)	Automatic Thread Trimming	Automatic Presser Foot Lifter	Direct Drive, Integrated	Presser Foot Lifting Height (mm)	Max. Speed (s.p.m)	Volume (mm)	Weight (kg)
JK-T1377E	TQ×116#	1	1	10-28	X(2.5~6.5) Y(0, 2.5~4.5)	✓	✓	✓	9	1500	625×465×440	28.6/34.5

JK-T373E



Needle Protection, Safe Production



Lcd Operation Panel,easy To Use



Integrated, Power Saving And Environmental Protection



Applicable To Several Button Feeding Devices

Model	Needle	Stitch No.	Thread No.	Button Diameter (mm)	Button Hole Size (mm)	Automatic Thread Trimming	Automatic Presser Foot Lifter	Presser Foot Lifting Height (mm)	Max. Speed (s.p.m)	Volume (mm)	Weight (kg)
JK-T373E	TQ×116#	1	1	10~28	X(2.5~6.5) Y(2.5~6.5)	✓	✓	9	1500	625×465×440	28.6/34.5
JK-T373ER	TQ×116#	1	1	10~28	X(2.5~6.5) Y(2.5~6.5)	✓	✓	13	1500	1220×840×132	146/195

PZ5

Spreading Machine For Knit And Woven



High Efficiency, Power Saving, Accuracy



precision



convenient maintenance



a variety of optional devices

machine size(mm)		
2630×1900×1000	2830×1900×1000	2930×1900×1000
maximum cloth width		
1900mm	2100mm	2200mm
table width		
2130mm	2330mm	2430mm
lay height		
One-Way:220mm	Zigzag:150mm	
machine weight		
340kg	360kg	380kg
diameter of cloth roll	weight of cloth roll	
600mm max	60kg max	
N.W./G.W	power supply	travel speed
495/755 kgs	1P/220V	94m/min max

PS5

Woven Fabric Spreading Machine



High Efficiency, Time Saving, labor Saving



Automatic cutting device



Edge control device

machine size(mm)		
2300×1450×800	2600×1450×800	
maximum cloth width		
1600mm63"	1900mm75"	
table width		
1830mm72"	2130mm84"	
lay height		
One-Way:200mm	Zigzag:150mm	
machine weight		
255kgs	290kgs	
diameter of cloth roll	weight of cloth roll	
600mm max	200kg max	
N.W./G.W	power supply	travel speed
495/755kgs	1P/220V	86m/min max



Heavy-duty Machine Series

JK-2002G

Large Hook Computerized Heavy-duty Lockstitch Machine



Top And Bottom Feeding, Large Needle Gauge, Fast Speed



Top And Bottom Feeding, High Efficiency



Full Function Panel, Easy to Operate



Intelligent Double Switch



Super Large Needle Gauge, Suitable for Light and Heavy Duty

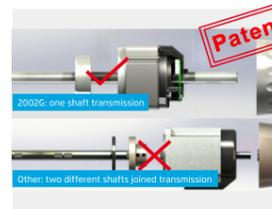

One Main Shaft

Model	Application	Needle	Thread number	Max needle gauge	Press footer height	Max speed (S.p.m)	Auto trimmer	Auto back stitch	Auto tension	Auto foot lifter	Volume (mm)	Weight (kg)
JK-2002GHC-3Z		DPx17 22#	2	8	7-16	3000	✓	✓	✓		725x285x580	37/45
JK-2002GHC-4Z	woolen	DPx17 22#	2	8	7-16	3000	✓	✓	✓	✓	725x345x580	43/51
JK-2002GHC-3Z-12	sweaters disposable	DPx17 22#	2	12	7-16	2800	✓	✓	✓		725x285x580	37/45
JK-2002GHC-4Z-12	slippers non-woven bags	DPx17 22#	2	12	7-16	2800	✓	✓	✓	✓	725x345x580	43/51
JK-2002BHC-Z	hats	DPx17 22#	2	8	7-16	3000					725x285x580	37/43
JK-2002BHC-Z-12		DPx17 22#	2	12	7-16	2800					725x285x580	37/43

Note: G means computerized B means Direct drive.



JK-2060G

Compound Feeding Computerized Lockstitch Machine For Heavy-duty Full-automatic, Compound Feeding, Large Space



JK-2030G

Top & Bottom Feeding Computerized Lockstitch Machine For Heavy-duty Full-automatic, Top And Bottom Feeding, Large Space

JK-2060G



Compound feeding



For 8 layers of leather



Large space

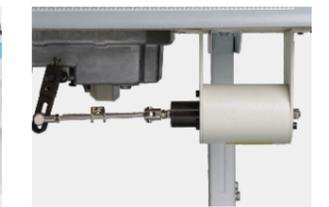

Auto presser foot lifter (optional)

Model	Application	Needle	Stitch No.	Thread No.	Needle Gauge (mm)	Two Presser Foot Working Distance (mm)	Presser Foot Lifting Height (mm)	Max. Speed (mm)	Automatic Thread Trimming	Auto Reverse	Electronic Thread Tension	Direct Drive, Integrated	Auto Presser Foot Lifter	Volume (mm)	Weight (kg)
JK-2060GHC-3Q	Sofa, Car Seat, Luggage, Shoes	DPx17 20-23#	1	2	1-9	2.5-5.5	8/16	2200	✓	✓	✓	✓		785x320x605	43/53
JK-2060GHC-4Q	Sofa, Car Seat, Luggage, Shoes	DPx17 20-23#	1	2	1-9	2.5-5.5	8/16	2200	✓	✓	✓	✓	✓	785x320x605	43/53

JK-2030G



Top and bottom feeding



For 8 layers of leather



Large space



Auto presser foot lifter (optional)

Model	Application	Needle	Stitch No.	Thread No.	Needle Gauge (mm)	Two Presser Foot Working Distance (mm)	Presser Foot Lifting Height (mm)	Max. Speed (mm)	Automatic Thread Trimming	Auto Reverse	Electronic Thread Tension	Direct Drive, Integrated	Auto Presser Foot Lifter	Volume (mm)	Weight (kg)
JK-2030GHC-3Q	Sofa, Car Seat, Luggage, Shoes	DPx17 20-23#	1	2	1-9	2.5-5.5	8/16	2200	✓	✓	✓	✓		785x320x605	43/53
JK-2030GHC-4Q	Sofa, Car Seat, Luggage, Shoes	DPx17 20-23#	1	2	1-9	2.5-5.5	8/16	2200	✓	✓	✓	✓	✓	785x320x605	43/53
JK-2030GHC-4PQ	Sofa, Car Seat, Luggage, Shoes	DPx17 20-23#	1	2	1-9	2.5-5.5	8/16	2200	✓	✓	✓	✓	✓	785x320x605	43/53

Note: P means pneumatic presser foot lifter.

H6

Top & Bottom feeding computerized lockstitch machine for heavy duty (Stepping type)



Accurate Needle Stitch, Strong Feeding



Accurate needle stitch, stable and reliable

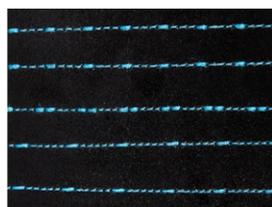

Variable stitches, fashionable and beautiful

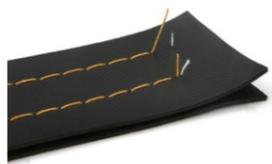

Condense stitch lock, short thread remaining



Noiseless reverse sewing, quiet and comfortable



One key to switch

Model	Application	Needle	Thread no.	Needle Length (mm)	Presser Foot Lifter Height (mm)	Max Speed (s.p.m)	Auto Presser Foot Lifter	Volume (mm)	Weight (kg)
H6-CZ-3	Normal material	DPX17 20-23#	2	10	7.5-16	2200	/	725x280x558	41/48.5
H6-CZA-3	Light material	DPX17 18#	2	10	7.5-16	2200	/	725x280x558	41/48.5
H6-CZST-3	Glove	DPX17 14#	2	10	7.5-16	2200	/	725x280x558	41/48.5
H6-CZXB-3	Bag	DPX17 20-23#	2	10	7.5-16	2200	/	725x280x558	41/48.5
H6-CZZD-3	Cushion	DPX17 20-23#	2	10	7.5-16	2200	/	725x280x558	41/48.5
H6-CZ-4	Normal material	DPX17 20-23#	2	10	7.5-16	2200	electric	725x345x580	43/51
H6-CZA-4	Light material	DPX17 18#	2	10	7.5-16	2200	electric	725x345x580	43/51
H6-CZP-4	Normal material	DPX17 20-23#	2	10	7.5-16	2200	pneumatic	725x345x580	43/51
H6 ^P -CZ-3	Normal material, IoT	DPX17 20-23#	2	10	7.5-16	2200	/	725x280x558	41/48.5
H6 ^P -CZ-4	Normal material, IoT	DPX17 20-23#	2	10	7.5-16	2200	electric	725x345x580	43/51

H5K

Side cutter synchronous computerized heavy duty lockstitch sewing machine



Neat Cutting Edge, Separated Cutter, And Strong Durability



Separated cutter, good durability



Sealed design, no oil and no worries



Integration of mechanical and electric, Easy to use



Free setting, one key reset



Especially for heavy duty, neat cutting edge

Model	Needle	Thread no.	Needle Length (mm)	Presser Foot Lifter Height (mm)	Max Speed (s.p.m)	Auto Presser Foot Lifter	Volume (mm)	Weight (kg)
H2K-CZ	Dpx17 20-23#	2	8	7-16	2000	/	725x280x558	39/46
H5K-CZ-3	DPx17 20-23#	2	8	7-16	2000	/	725x280x558	39/46
H5K-CZ-4	DPx17 20-23#	2	8	7-16	2000	Electric	725x345x580	43.5/45.5
H5K-CZP-4	DPx17 20-23#	2	8	7-16	2000	pneumatic	725x345x580	43.5/45.5

Note: The standard cutting width is 4.8mm, optional 3.2mm, 6.4mm

H5

Top & Bottom Feeding Computerized Lockstitch Machine For Heavy-duty



Strong Feeding, Easy To Use



Strong Feeding, High Efficiency

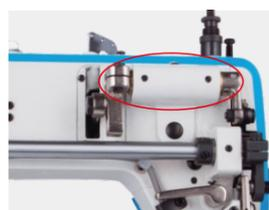

Sealed Shaft, No Oil No Trouble

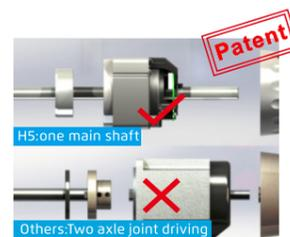

One Main Shaft



One Key To Factory Reset

S7

Intelligent-Control Computerized Post Bed Roller Feed Sewing Machine



Accurate Needle Stitch, Noiseless And Faster



Short Thread Remaining (optional)



Rotary Type Pressure Adjustment, Easy To Adjust



Different Stitch Length, Free Switching

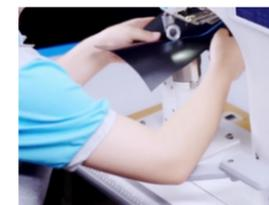

New Reverse Wrench, Operate Easily



Stepper Motor Drive, Accurate Stitch

Model	Application	Needle	Thread No.	Needle Gauge (mm)	Presser Foot Lifting Height (mm)	Max. Speed (s.p.m)	Automatic Presser Foot Lifting	Volume (mm)	Weight (kg)
H5-CZ-3	Normal Material	Dp×17 20-23#	2	8	7.5-16	2200		725×285×580	40.5/43
H5-CZST-3	Glove	Dp×5 11-17#	2	8	5-16	1800		725×285×580	40.5/43
H5-CZXB-3	Bag	Dp×17 20-23#	2	8	7.5-16	2200		725×285×580	40.5/43
H5-CZZD-3	Cushion	Dp×17 20-23#	2	8	7.5-16	2200		725×285×580	40.5/43
H5-CZ-4	Normal Material	Dp×17 20-23#	2	8	7.5-16	2200	✓	725×345×580	43/45.5
H2-CZ	Normal Material	Dp×17 20-23#	2	8	7.5-16	2200		725×285×580	40.5/43
H2-CZ-12	Normal Material	Dp×17 20-23#	2	12	7.5-16	2200		725×285×580	40.5/43
H2-CZST	Glove	Dp×5 11-17#	2	8	5-16	1800		725×285×580	40.5/43
H2-CZXB	Bag	Dp×17 20-23#	2	8	7.5-16	2200		725×285×580	40.5/43
H2-CZZD	Cushion	Dp×17 20-23#	2	8	7.5-16	2200		725×285×580	40.5/43

Note:H5 is computerized type with auto trimmer, auto reverse, thread tension, optional auto presser foot lifter(-4).
H2 is direct-drive type.

Model	Max.Speed (S.p.m)	Needle	Presser Foot Lifter Height (mm)	Maximum Stitch Length (mm)	Needle Bar Stroke	Auto Trimmer	Auto Reverse Sewing	Auto Presser Foot Lifter	Short Thread Tail	Volume (mm)	Weight (kg)
S7-91-T	2500	DP×5 9-23#	12	5	41	✓	✓	✓		882×375×794	63/72
S7-92-T	2000	DP×5 9-23#	12	5	41	✓	✓	✓		882×375×794	63/72
S7-91	2500	DP×5 9-23#	12	5	41	✓	✓	✓		882×375×794	63/72
S7-92	2000	DP×5 9-23#	12	5	41	✓	✓	✓		882×375×794	63/72
S7-91CX-T	2500	DP×5 9-23#	12	5	41	✓	✓	✓	✓	882×375×794	63/72
S7-91CX	2500	DP×5 9-23#	12	5	41	✓	✓	✓	✓	882×375×794	63/72

Note: Button is standard, T:LCD, X:Short thread tail, C:Chinese hook

S5

High Speed Computerized Post Bed Roller Feed Sewing Machine



Beautiful Stitches, Quick Service, Easy to Use



Built-in Panel, Easy to Operate

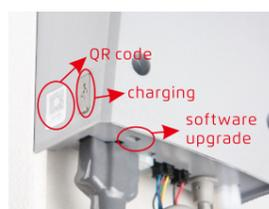

Intelligent control double USB



Aluminum Handwheel with Scale Ring

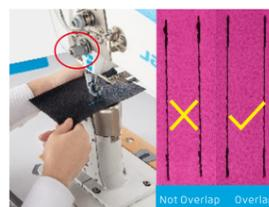

Stitch Overlapping Ratio 100%



Strong Feeding

Model	Max. Speed (S.p.m)	Needle	Presser Foot Lifter Height (mm)	Max. Stitch Length (mm)	Needle Bar Stroke (mm)	Automatic Thread Trimmer	Auto Backstitch	Auto Presser Foot Lifter	Short Tail	Volume (mm)	Weight (kg)
S5-91	3000	INDPX5#16	12	6.3	41	✓	✓	✓		812×375×724	67/76
S5-91CX	3000	INDPX5#16	12	6.3	41	✓	✓	✓	✓	812×375×724	67/76
S5-92	2000	INDPX5#16	12	4.1	41	✓	✓	✓		812×375×724	67/76

JK-6671C/6672C

Intelligent-Control Computerized Post Bed Roller Feed Sewing Machine



Integration Of Mechanical And Electric, Cost-effective



Voice Guide, One-key Factory Reset



Integrated Control Box , High Efficiency



Repeated Stitch Rate Is 100%



Strong Puncture Ability



Short Thread Remaining (optional)

Model	Max. Speed (S.p.m)	Needle	Presser Foot Lifter Height (mm)	Max. Stitch Length (mm)	Needle Bar Stroke (mm)	Automatic Thread Trimmer	Auto Backstitch	Auto Presser Foot Lifter	Short Tail	Volume (mm)	Weight (kg)
JK-6671C	3000	INDPX5#16	12	6.5	41	✓	✓	✓		812×375×724	67/76
JK-6672C	2000	INDPX5#16	12	5	41	✓	✓	✓		812×375×724	67/76

CONFIGURATION

Shirt

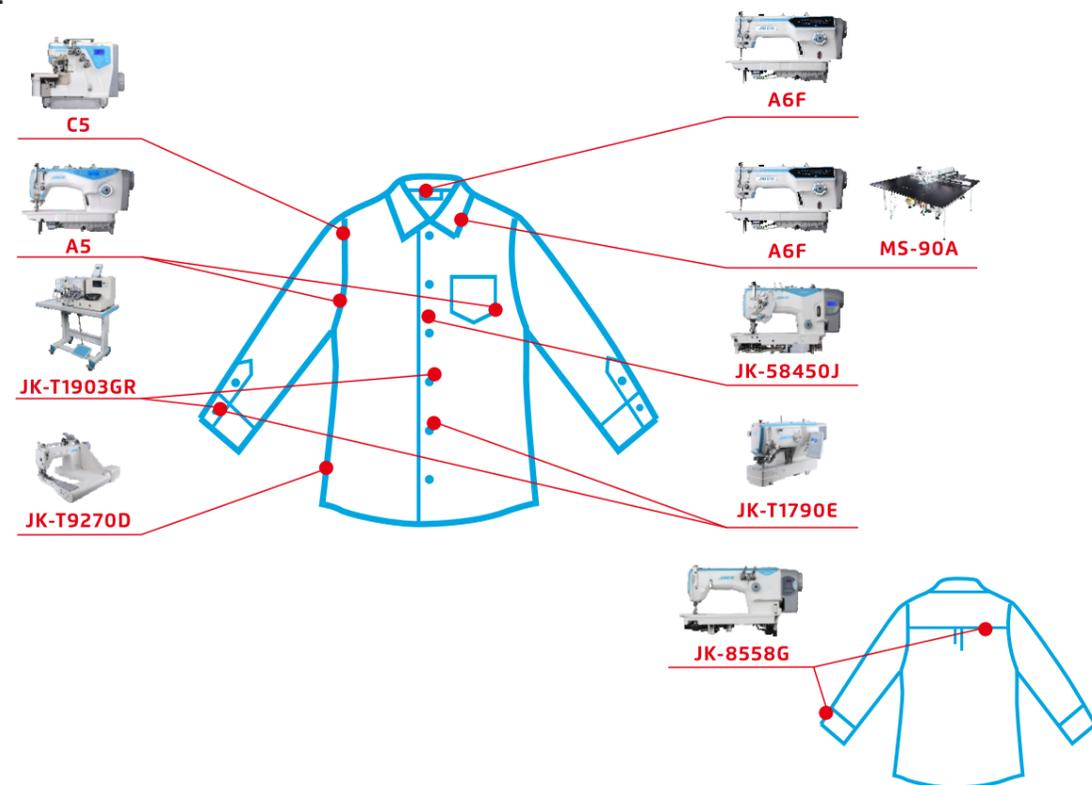

Jeans

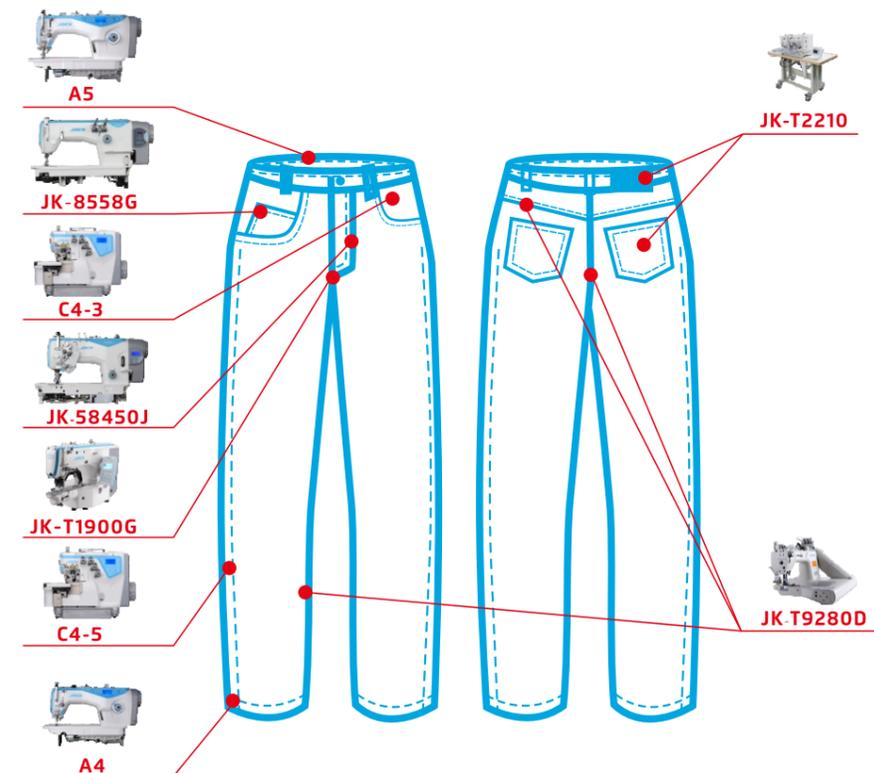

Trousers

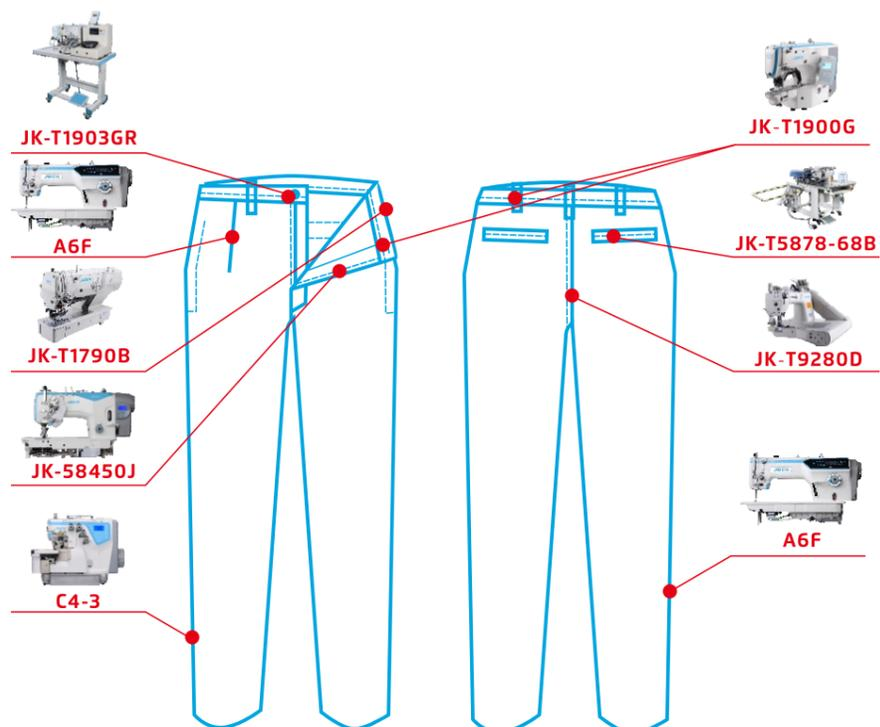

Bra

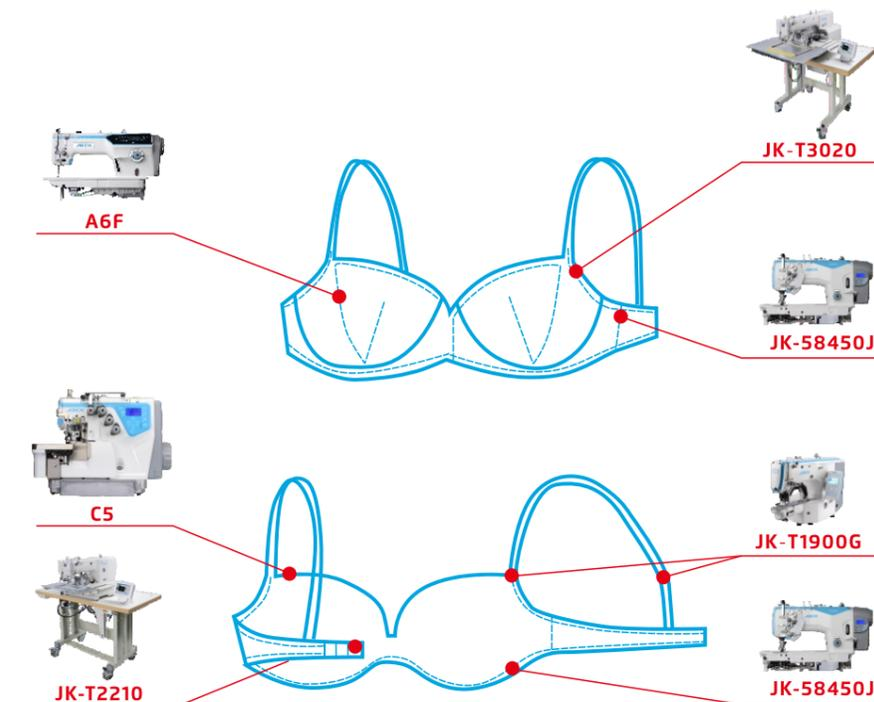

Briefs

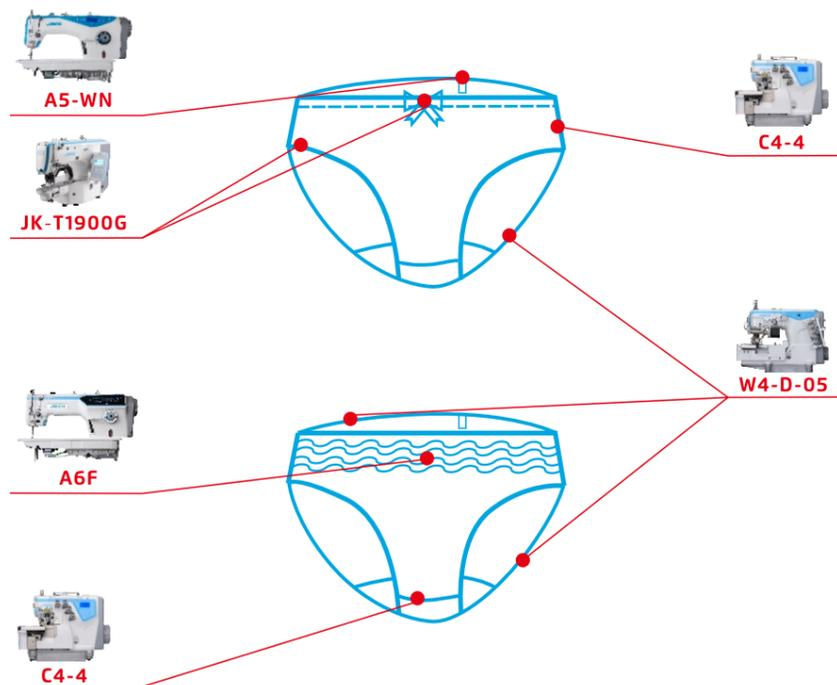

Dresses

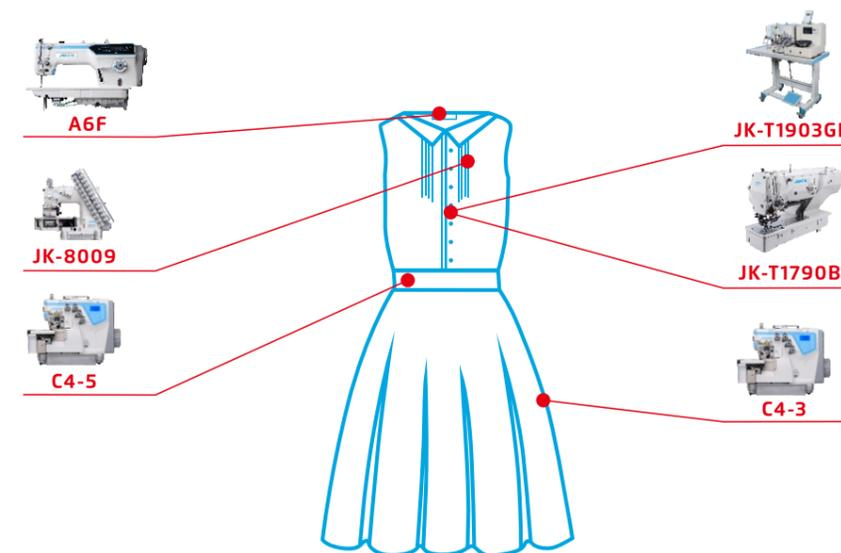

Polo-shirt

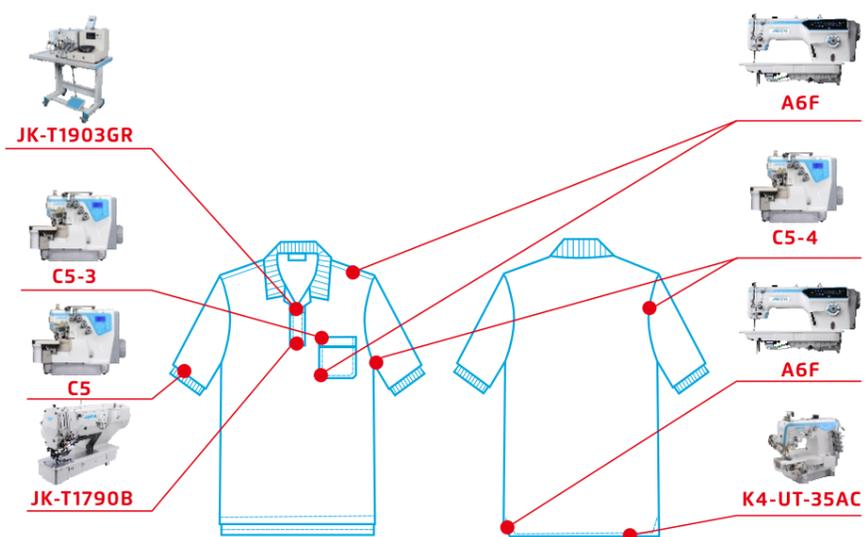

Bag

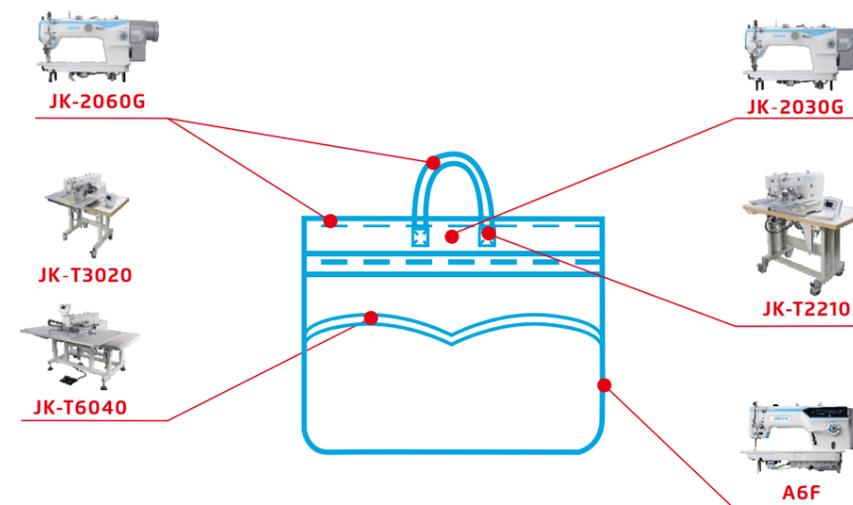

STITCH TABLE

Lockstitch



Lockstitch with short thread tail



Edge cut and tape binder



Cutting after sewing



Double needle lock stitch



Double needle corner stitch

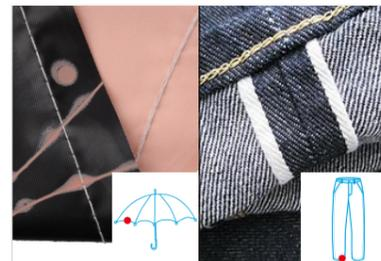

Single needle chain stitch

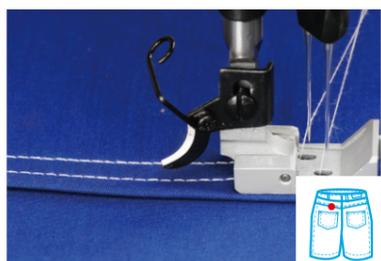

Double needle chain stitch



Triple needle chain stitch



Heavy duty

Overlock



Pocket double chain stitch



Fabric joint sewing

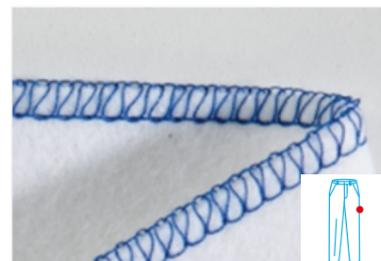

Three threads stitch



Three threads back latching stitch

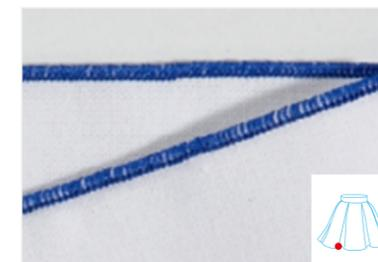

Three threads baby overlock stitch



Three threads blindstitch hemming

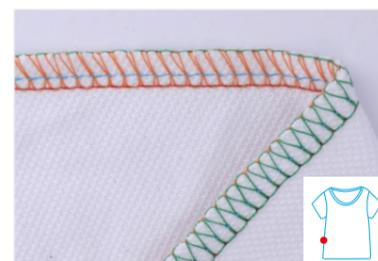

Four threads stitch



Four threads back latching stitch



Four threads shirring stitch



Four thread tape attach stitch



Five threads stitch



Five threads heavy duty stitch

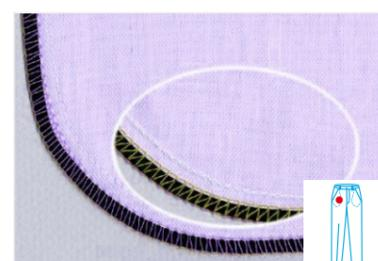

Five threads for attaching tape



Six threads sewing



Four threads variable top feed

Four Thread Interlock

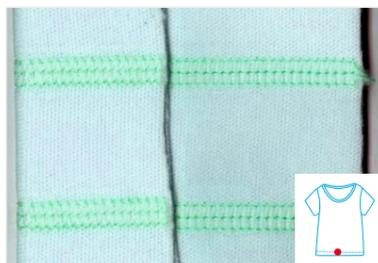

Plain seaming



Tape binding



Covering stitch (one side)



Covering stitch

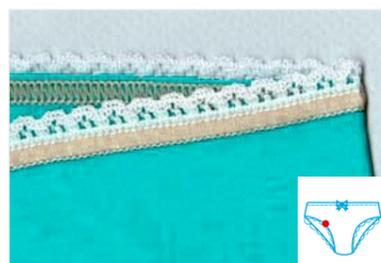

Elastic lace attaching

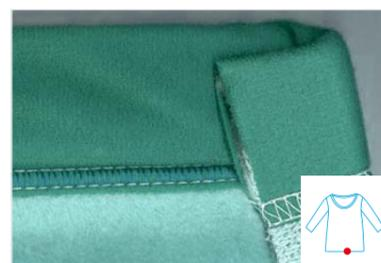

Bottom hemming

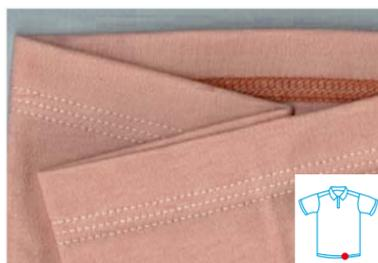

Bottom hemming (left cutter)



Cylinder cover stitch



Elastic attaching

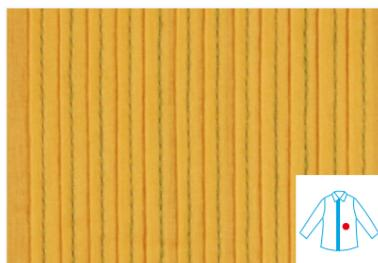

T-shirt folding seaming



Tape attaching



Waist band

Button Holing/Button Attaching

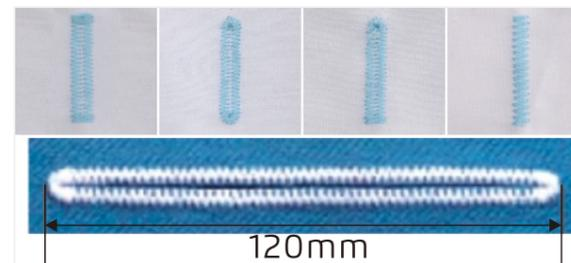

Button holing stitch

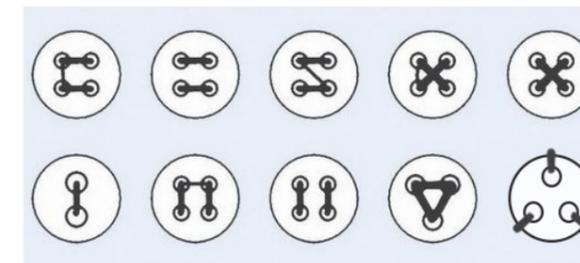

Button attaching stitch

Bartacking Machine Stitch



Bartacking stitch



Cap hole stitch



Small pattern

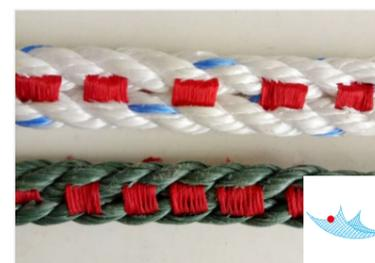

Fishing net

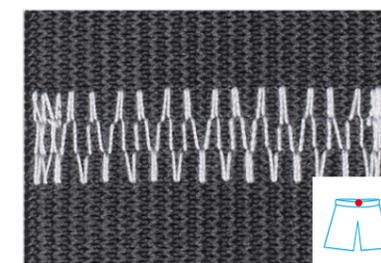

Elastic joint



Cross bartacking stitch



Suits bartacking stitch

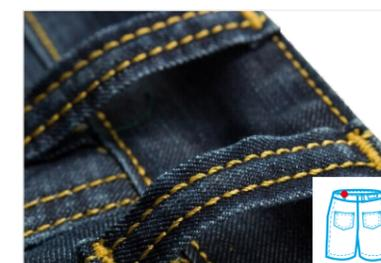

Jeans bartacking stitch

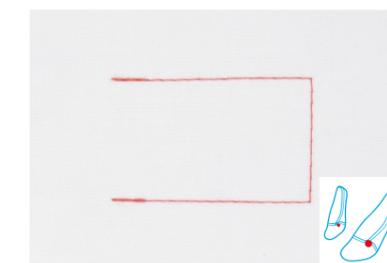

Bartacking for socks

Pattern Stitch

Apparel



Non-apparel



Home textile



Others



Chain Stitch



Triple needle feed-off-the arm machine



Double needle feed-off-the arm machine

Placket Samples



Visible placket

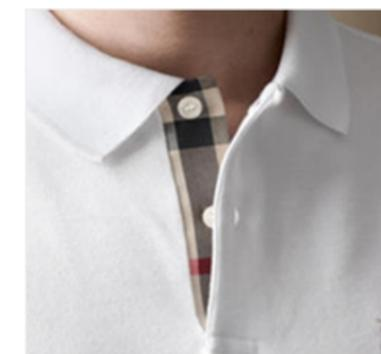

Invisible placket



"V" placket

Pocket Stitch



Single welt pocket

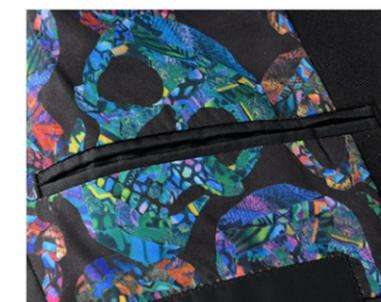

Double welt pocket



Double welt pocket with flap